

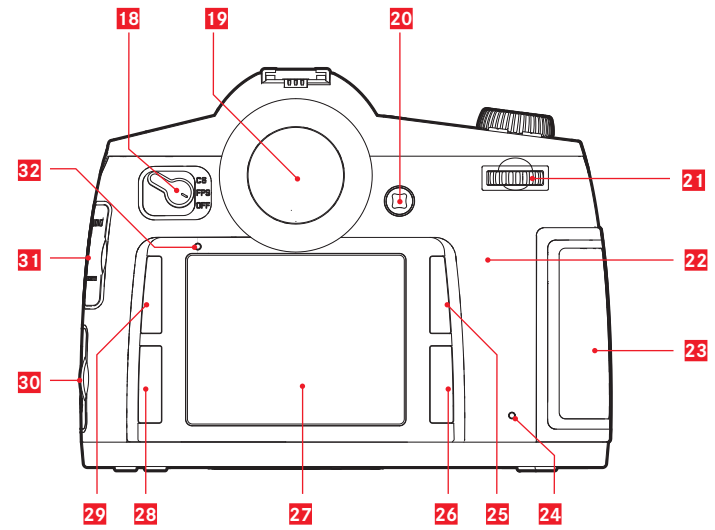

LEICA S

Instructions

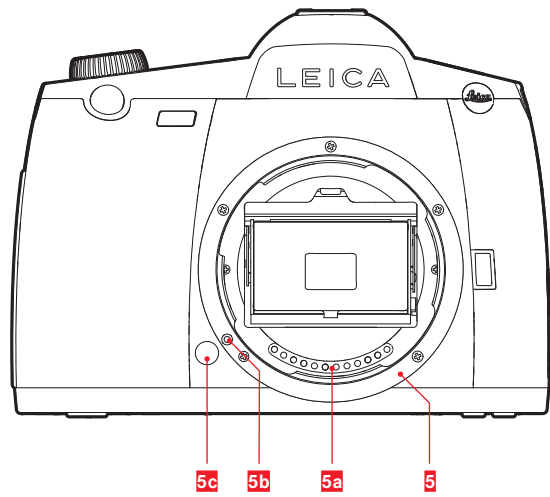

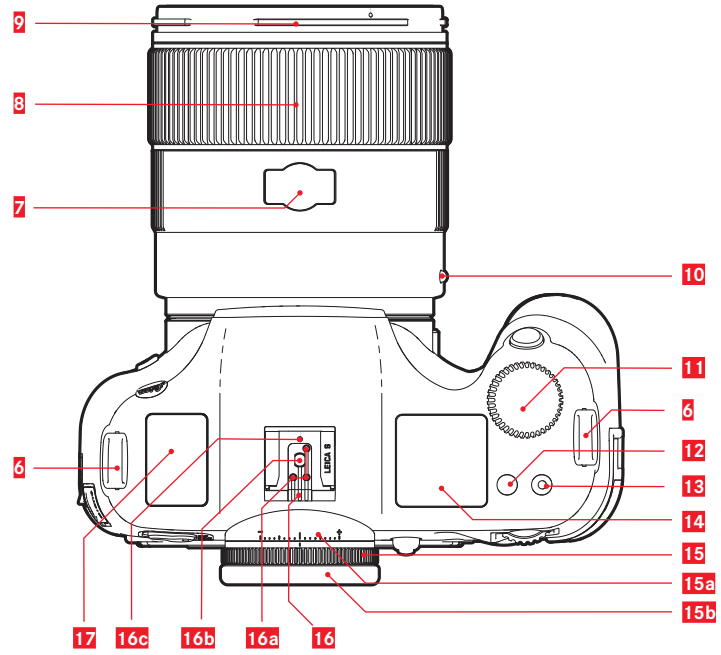
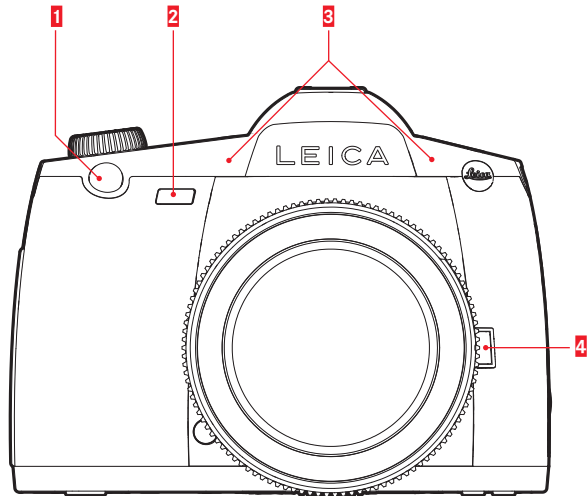
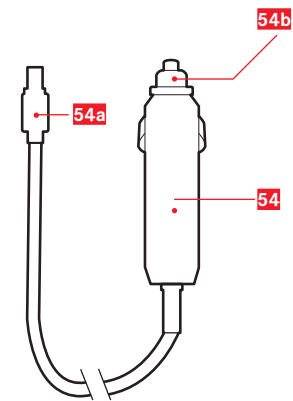
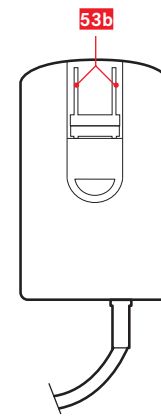
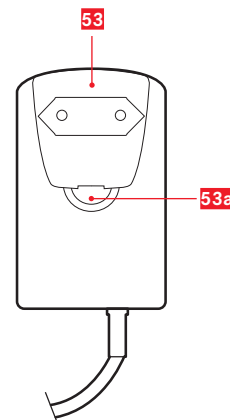
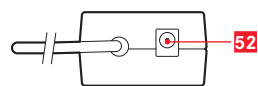
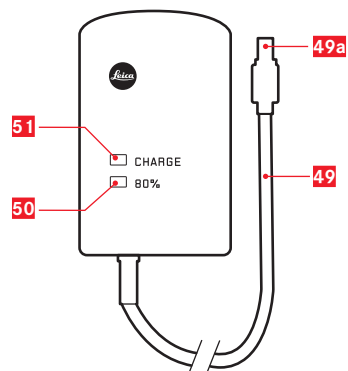
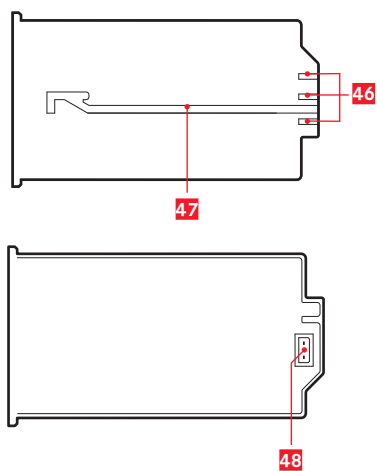
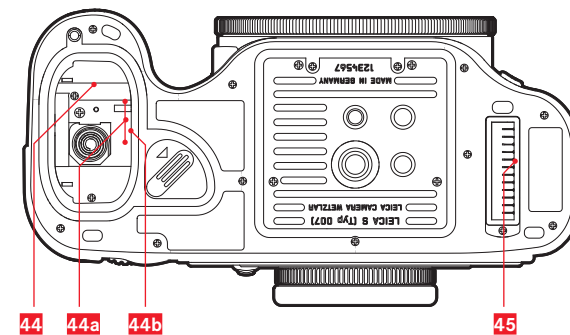
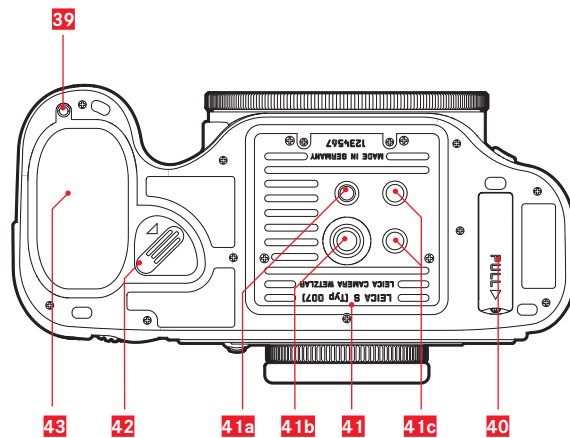
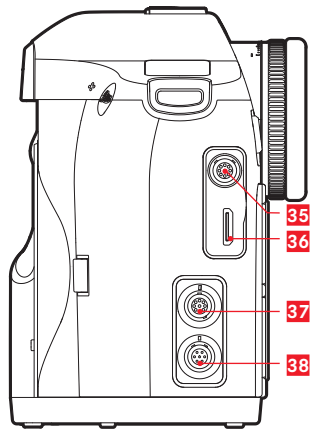
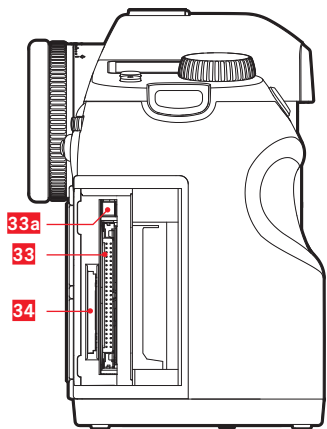







**Leica S**  
Instructions

## FOREWORD

Dear Customer,

Leica would like to thank you for purchasing the Leica S and congratulate you on your choice. With this unique medium-format digital SLR camera, you have made an excellent choice.

We wish you a great deal of pleasure and success using your new Leica S.

In order to make best use of all the opportunities offered by this high performance camera, we recommend that you first read this instruction manual.

Your Leica Camera AG

### Note:

Leica is constantly working on developing and optimizing the Leica S. As many functions on digital cameras are controlled purely electronically, improvements and extensions to the range of functions may need to be installed on the camera at a later date. To do this, Leica releases what are known as firmware updates at irregular intervals. Cameras are always supplied from the factory with the latest firmware, but you can easily download the updates to your camera yourself from our website.

If you register as an owner on the Leica Camera website, you will receive a newsletter informing you when a new firmware update is available. Further information on registration and on firmware updates for your Leica S and on any changes or additions to the details in this manual can be found on our website under "Customer Service" at:

<https://owners.leica-camera.com>

To check whether your camera and lenses are running the latest firmware version, select menu option "Firmware" (see p. 66, 16-19).

**FCC Note:**

This equipment has been tested and found to comply with the limits for a Class B digital device, pursuant to Part 15 of the FCC Rules. These limits are designed to provide reasonable protection against harmful interference in a residential installation. This equipment generates, uses, and can radiate radio frequency energy and, if not installed and used in accordance with the instructions, may cause harmful interference to radio communications. However, there is no guarantee that interference will not occur in a particular installation. If this equipment does cause harmful interference to radio or television reception, which can be determined by turning the equipment off and on, the user is encouraged to try to correct the interference by one or more of the following measures:

- Reorient or relocate the receiving antenna.
- Increase the separation between the equipment and receiver.
- Connect the equipment into an outlet on a circuit different from that to which the receiver is connected.
- Consult the dealer or an experienced radio/TV technician for help.

**FCC Caution:**

To assure continued compliance, follow the attached installation instructions and use only shielded interface cables with ferrite core when connecting to computer or peripheral devices. Any changes or modifications not expressly approved by the party responsible for compliance could void the user's authority to operate this equipment.

Trade Name: LEICA  
 Model No.: LEICA S (Typ 007)  
 Responsible party/  
 Support contact: Leica Camera Inc.  
 1 Pearl Count, Unit A  
 Allendale, New Jersey 07401  
 Tel.: +1 201 995 0051  
 Fax: +1 201 995 1684  
 technicalinfo@leicacamerausa.com

This device complies with Part 15 of the FCC Rules. Operation is subject to the following two conditions: (1) This device may not cause harmful interference, and (2) this device must accept any interference received, including interference that may cause undesired operation.

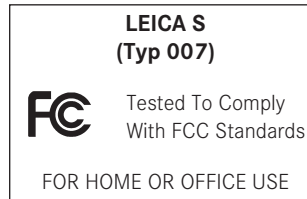
**Contains FCC ID: N5AS007**

This transmitter must not be co-located or operated in conjunction with any other antenna or transmitter. This equipment complies with FCC radiation exposure limits set forth for an uncontrolled environment and meets the FCC radio frequency (RF) Exposure Guidelines. This equipment is tested for specific absorption ratio (SAR) and complies with FCC/IC radiation exposure limits set forth for an uncontrolled environment. This device complies with FCC/IC SAR limit of 1.6 W/kg. For body worn operation, this equipment has been tested and meets the FCC/IC RF exposure guidelines when used with the Leica Camera AG accessories supplied or designated for this product that have no metallic component in the assembly. Use of other accessories may not ensure compliance with FCC/IC RF exposure guidelines.

**For Canada only:**

CAN ICES-3 (B)/NMB-3(B)

This device complies with RSS-210 of the IC Rules. Operation is subject to the following two conditions:

- (1) This device may not cause harmful interference,
- (2) This device must accept any interference received, including interference that may cause undesired operation of the device.

This equipment complies with IC radiation exposure limits set forth for an uncontrolled environment and meets RSS-102 of the IC radio frequency (RF) Exposure rules. This equipment is tested for specific absorption ratio (SAR) and complies with FCC/IC radiation exposure limits set forth for an uncontrolled environment. This device complies with FCC/IC SAR limit of 1.6 W/kg. For body worn operation, this equipment has been tested and meets the FCC/IC RF exposure guidelines when used with the Leica Camera AG accessories supplied or designated for this product that have no metallic component in the assembly. Use of other accessories may not ensure compliance with FCC/IC RF exposure guidelines.

## TABLE OF CONTENTS

Foreword .....	2	Basic picture settings	
Warning messages .....	6	Photo file format .....	22
CE mark .....	6	JPEG settings	
Legal information .....	6	Resolution .....	22
Disposal of electrical and electronic equipment .....	6	Working color range .....	22
Package contents .....	6	Contrast, focus, color saturation .....	22
		Resolution .....	22
Designation of parts .....	7	White balance .....	22
		Automatic and fixed settings .....	23
Preparations		Direct color temperature setting .....	23
Attaching the carrying strap .....	8	Manual setting by metering .....	23
Charging the battery .....	8	ISO sensitivity .....	24
Inserting and removing the battery into/from the camera .....	11	Storage of picture data / memory card management .....	25
Charge level displays .....	11		
Changing memory cards .....	11	Recording mode	
Changing the focusing screen .....	13	For photos	
Leica S lenses .....	14	Shutter release button .....	26
Fitting and removing .....	14	Interval shooting .....	26
Adjusting the eyepiece .....	15	Live View mode .....	27
Turning the camera ON and OFF .....	15	Exposure simulation .....	27
		Displays in Live View mode .....	27
Menu control .....	16	Histogram .....	27
Navigating in the menu / setting the functions .....	17	Clipping displays .....	27
Quick access to menu functions .....	18	Marking of clearly focused subjects (focus peaking) .....	28
		Grid .....	28
Presets		Horizon .....	28
Basic camera settings		Masking .....	28
Menu language .....	20	Enlarging the Live View monitor image .....	28
Date and time .....	20	Distance setting .....	29
Auto power OFF .....	20	Manual setting of the focus - <b>MF</b> .....	29
Monitor and top panel display .....	21	Automatic setting .....	29
Signal tones .....	21	<b>AFS</b> - focus priority .....	29
		<b>AFC</b> - shutter release priority .....	29
		Moving the autofocus metering field in Live View mode .....	29
		Exposure metering .....	30
		Exposure metering methods .....	30
		Spot metering .....	30
		Center weighted metering .....	30
		Multi-field metering .....	30
		Metering memory lock .....	32
		Saving with the Joystick .....	32
		Exposure compensation .....	32
		Bracketing .....	33
		Values above and below the metering range .....	34

Exposure control			Miscellaneous	
Automatic program .....	30	Review mode	System accessories.....	53
Program shift.....	31	Automatic review of last picture.....	Spare parts .....	53
Aperture priority.....	31	Review for unlimited time .....		
Shutter speed priority.....	31	Video playback.....	Precautions and care instructions .....	54
Manual setting of aperture and exposure time .....	33	Setting the volume .....	General precautions .....	54
Taking photographs with the self-timer.....	34	Displays in Review mode .....	Care instructions.....	54
Mirror lock-up.....	35	Review with histogram and clipping indicators.....	Cleaning the sensor.....	55
Depth of field preview button .....	35	Viewing other pictures / scrolling.....	Storage .....	55
		Enlarging the detail .....		
Additional functions		Stepwise enlarging .....	Index .....	56
User/application-specific profiles.....	36	Maximum enlargement in one step.....		
Resetting all custom settings .....	36	Moving the detail .....	Technical data .....	58
Folder management.....	37	Simultaneous viewing of several reduced pictures .....		
Formatting of memory card(s).....	37	Selection of one of the reduced pictures .....	The displays	
Marking picture data for copyright protection .....	38	Protecting pictures / clearing delete protection.....	In the viewfinder.....	60
Recording the location with GPS.....	38	Deleting pictures .....	In the top panel display.....	61
			In the monitor .....	62
Flash mode		Additional functions	Menu items.....	66
General information on flash exposure measurement and control.....	39	Transferring data to a computer.....	Leica service addresses .....	67
Compatible flash units .....	39	Connecting and transferring the data using card scanners.....		
Flash sync speed.....	39	Data structure on the memory card .....		
Selecting the sync speed / sync speed range.....	40	LEICA Image Shuttle.....		
Selecting the firing moment .....	40	Installing firmware updates.....		
Attaching the flash unit.....	40	Wireless data transmission and remote control of the camera.....		
Settings for camera-controlled				
automatic flash mode .....	41			
TTL flash mode .....	41			
Linear flash mode (HSS) .....	41			
Stroboscope flash mode with system-compatible flash units .....	41			
Flash exposure displays in the viewfinder with				
system-compatible flash units.....	42			
Flash photography with the flash unit-integrated automatic computer.....	42			
Manual flash photography with constant flash power.....	42			
Flash photography via the X contact .....	42			
Flash photography via the flash / lower LEMO® jack.....	42			
Video recordings.....	43			

## WARNING MESSAGES

- Modern electronic components react sensitively to electrostatic discharge. As you can easily pick up charges of tens of thousands of volts by walking on synthetic carpets, for example, a discharge can occur when you touch your Leica S, particularly if it is lying on a conductive surface. If only the camera body is touched, this discharge is harmless to the electronics. However, despite built-in safety circuits, outer contacts such as those in the bottom of the camera should not be touched if at all possible for safety reasons.
- For any cleaning of the contacts, please do not use an optical microfiber cloth (synthetic); use a cotton or linen cloth instead! Before touching the contacts, you can make sure you discharge any electrostatic charge by deliberately touching a heating or water pipe (conductive, earthed material). You can also avoid soiling and oxidization of the contacts by storing your Leica S in a dry place with the lens or bayonet cover fitted!
- Use only the recommended accessories to prevent faults, short circuits or electric shock.
- The Leica S is protected against spray water and dust. However, it should not be exposed to rain for prolonged periods.
- Do not attempt to remove parts of the body (covers); qualified repairs can be carried out only at authorized service centers.

## LEGAL INFORMATION

- Please ensure that you strictly observe copyright laws. The recording and publication of pre-recorded media such as tapes, CDs, or other published or broadcast material may contravene copyright laws.
- This also applies to all of the software supplied.
- The SD, HDMI, CF and USB logos are trademarks.
- Other names, company and product names referred to in these instructions are trademarks or registered trademarks of the relevant companies.

## The CE identification of our products documents compliance with the fundamental requirements of the respective valid EU directives.



The production date of your camera can be found on the stickers in the warranty card and/or on the packaging.

The date convention is: **Year/Month/Day**

In the menu, under **Camera Information**, you will find the specific approvals for this camera under the point **Regulatory Information**.



## DISPOSAL OF ELECTRICAL AND ELECTRONIC EQUIPMENT

(Applies within the EU, and for other European countries with segregated waste collection systems.)

This device contains electrical and/or electronic components and should therefore not be disposed of in general household waste. Instead it should be disposed of at a recycling collection point provided by the local authority.

This costs you nothing. If the device itself contains replaceable (rechargeable) batteries, these must be removed first and, if necessary, also be disposed of in line with the relevant regulations.

Further information on this issue is available from your local administration, your local waste collection company, or in the store where you purchased this device.

## PACKAGE CONTENTS

Before using your Leica S for the first time, please check that the accessories supplied are complete.

- Li-Ion Battery S BP-PRO 1
- Quick Charger S with interchangeable mains plugs
- Carrying strap
- Bayonet cover
- Eyepiece cover

## MEANING OF THE DIFFERENT NOTE CATEGORIES IN THIS MANUAL

### Note:

Additional information

### Important:

Failure to observe the instructions may cause damage to the camera, accessories or the photos.

### Caution:

Failure to observe the instructions may cause personal injury.

## DESIGNATION OF PARTS

### Front view

- 1** Shutter release button
- 2** Self-timer LED / sensor for white balance
- 3** Microphones
- 4** Depth of field preview/function button
- 5** Bayonet with
  - a. contact strip
  - b. Index point for fitting the lens
  - c. Lens release button

### Top view

- 6** Carrying strap attachment
- 7** Window for range scale
- 8** Focusing dial
- 9** Lens hood bayonet
- 10** Red index button for changing lenses
- 11** Shutter speed setting dial
- 12** Live View button
- 13** Video record button
- 14** Top panel display
- 15** Diopter setting dial with
  - a. scale
  - b. Eyecup
- 16** Accessory shoe with
  - a. center (firing) contact
  - b. Control contacts
  - c. Bore for locking pin
- 17** GPS antenna

### Rear view

- 18** Main switch with stop positions
- 19** Viewfinder
- 20** Joystick
- 21** Rear setting dial
- 22** Speaker
- 23** Cover (closed)
- 24** LED for recording / data storage on card
- 25** Review / menu control / function button
- 26** Menu control / function button
- 27** Monitor
- 28** Menu control / function button
- 29** Menu control / function button
- 30** Cover (closed)
- 31** Cover (closed)
- 32** Brightness sensor

### View from right (view without cover)

- 33** CF card slot with
  - a. ejection slide
- 34** SD card slot

### View from left (view without covers)

- 35** LEMO® audio socket
- 36** HDMI socket
- 37** LEMO® USB 3.0 socket
- 38** LEMO® remote control / flash synchronization / audio in/out socket

### Bottom view

- 39** Index hole for guide pin of multifunction hand grip
- 40** Cover
- 41** Tripod plate with
  - a. ¼" thread
  - b. ⅜" thread
  - c. Index holes for twist lock
- 42** Battery release lever
- 43** Battery
- 44** Battery compartment (battery removed) with
  - a. contacts
  - b. Guide strip
- 45** Contact strip for multifunction hand grip (cover removed)

### Battery

- 46** Contacts
- 47** Guide slot
- 48** Socket for charger plug

### Charger

- 49** Battery connecting cable fixed to camera with
  - a. 3-pin plug
- 50** Orange LED for charge indicator
- 51** Green LED for display of the charging process
- 52** 2-pin socket for car charging cable
- 53** Interchangeable mains plug (Europe/GB/AUS) with
  - a. release button
- 54** USA mains plug (interchangeable plug removed)
- 55** Car charging cable with
  - a. 2-pin plug for charger
  - b. Plug for cigarette lighter

## PREPARATIONS

### ATTACHING THE CARRYING STRAP

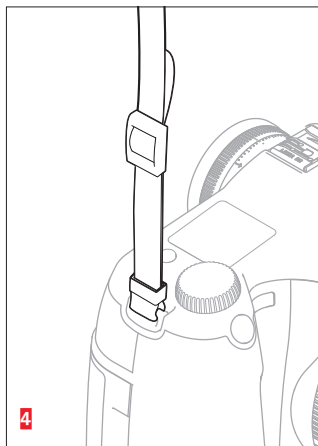
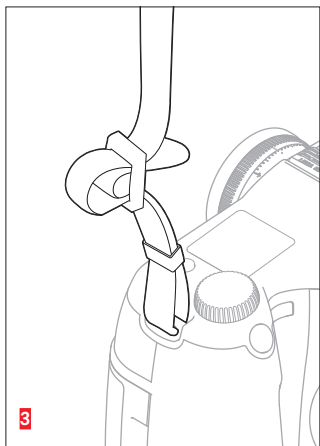
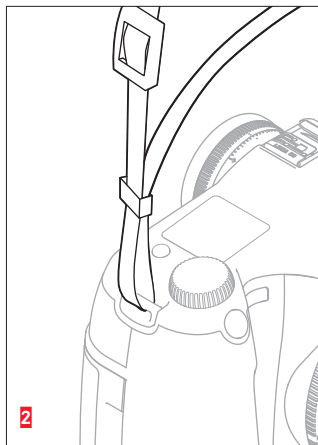
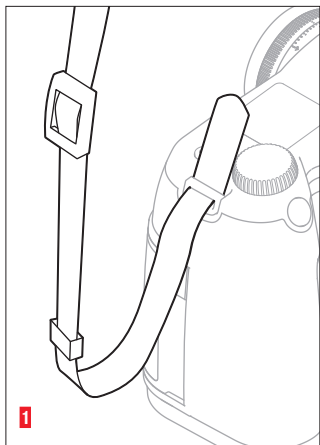

### CHARGING THE BATTERY

The Leica S is powered by a lithium ion battery (A).

#### Important:

Batteries from the earlier Leica S models (Order No.14 429) cannot be used either in the Leica S (Typ 007) or in the multifunction hand grip. Please use only the Leica battery S **BP-PRO1** (Order No. 16 039).

#### Caution:

- Only the battery type specified and described in this manual, or battery types specified and described by Leica Camera AG, may be used in this camera.
- These batteries may only be used in the units for which they are designed and may only be charged exactly as described below.
- Using this battery contrary to the instructions and using non-specified battery types can result in an explosion under certain circumstances!
- The batteries must not be exposed to sunlight or heat for prolonged periods, or to humidity or moisture. Likewise, the batteries must not be placed in a microwave oven or a high pressure container as this results in a risk of fire or explosion!
- Damp or wet batteries must not be charged or used in the camera under any circumstances!
- Always ensure that the battery contacts are clean and freely accessible. Whilst lithium ion batteries are proofed against short-circuit, they should still be protected against contact with metal objects such as paper clips or jewelry. A short-circuited battery can get very hot and cause severe burns.
- If a battery is dropped, check the casing and the contacts immediately for any damage. Using a damaged battery can damage the camera.
- In case of noise, discoloration, deformation, overheating or leaking fluid, the battery must be removed from the camera or charger immediately and replaced. Continued use of the battery results in a risk of overheating, which can cause fire and/or explosion!
- In case of leaking fluid or a smell of burning, keep the battery away from sources of heat. Leaked fluid can catch fire!

- Only the charger specified and described in these instructions, or other chargers specified and described by Leica Camera AG, may be used. The use of other chargers not approved by Leica Camera AG can cause damage to the batteries and, in extreme cases, can cause serious or life-threatening injuries.
- The charger supplied should be used exclusively for charging this battery type. Do not attempt to use it for other purposes.
- Ensure that the power socket used is freely accessible.
- The car charging cable supplied must never be connected while the charger is connected to the mains.
- Battery and charger must not be opened. Repairs may only be carried out by authorized service centers.
- Keep batteries out of the reach of children. Batteries can cause suffocation if swallowed.

#### First aid:

- If battery fluid comes into contact with the eyes, there is a risk of blinding! Rinse the eyes immediately with clear water. Do not rub the eyes!
- Obtain medical assistance immediately.
- If leaked fluid gets onto the skin or clothing, there is a risk of injury. Wash the areas concerned with clear water. Obtain medical assistance.



#### Notes:

- The battery must have a temperature of +10° to +30°C to be charged (otherwise the charger will not turn on, or will turn off again).
  - Lithium ion batteries can be charged at any time, regardless of their current charge level. If a battery is only partly discharged when charging starts, it is charged to full capacity faster.
  - A new battery only reaches its full capacity after it has been fully charged and – by use in the camera – discharged again 2 or 3 times. This discharge procedure should be repeated roughly every 25 cycles.
  - Both battery and charger become warm during charging. This is normal and not a malfunction.
  - If the two LEDs flash rapidly (> 2 Hz) after the start of charging, this indicates a charging error (e.g. maximum charging time exceeded, voltages or temperatures outside the permitted ranges, or short circuit). In this case, disconnect the charger from the mains and remove the battery. Ensure that the above temperature conditions are met and then restart the charging process.
  - If the problem persists, please contact your dealer, the Leica office in your country or Leica Camera AG.
  - Lithium ion batteries should only be stored partly charged, i.e. not when fully discharged or fully charged. For very long storage periods, you should charge the battery for approx. 15 minutes roughly twice a year to avoid a deep discharge.
  - Rechargeable lithium ion batteries generate power through internal chemical reactions. These reactions are also influenced by the ambient temperature and humidity. To ensure a maximum service life of the battery, it should not be exposed to constant extremes of temperature (e.g. in a parked car in the summer or winter).
  - Even when used under optimum conditions, every battery has a limited service life! After several hundred charging cycles, this becomes noticeable as the operating times become significantly shorter.
  - Dispose of damaged batteries in accordance with the relevant regulations (see p. 6, 54) at an approved collection point for proper recycling.
- The replaceable battery provides power to a back-up battery which is permanently fitted in the camera. This back-up battery retains the set time and date for up to 3 months. If this back-up battery becomes discharged it must be recharged by inserting a charged main battery. Once the replaceable battery has been inserted, the full capacity of the back-up battery is recovered after about 60 hours. This process does not require the camera to be turned on. In this case, however, the time and date have to be set again.
  - Remove the battery if you will not be using the camera for a long period of time. When doing so, turn the camera off using the main switch first. Otherwise after several weeks the battery could undergo deep discharge, i.e. the voltage is sharply reduced, as the camera still consumes a small amount of current (e.g. for saving your settings) even when it is turned off.

## PREPARATION OF THE CHARGER

### for use outside the USA

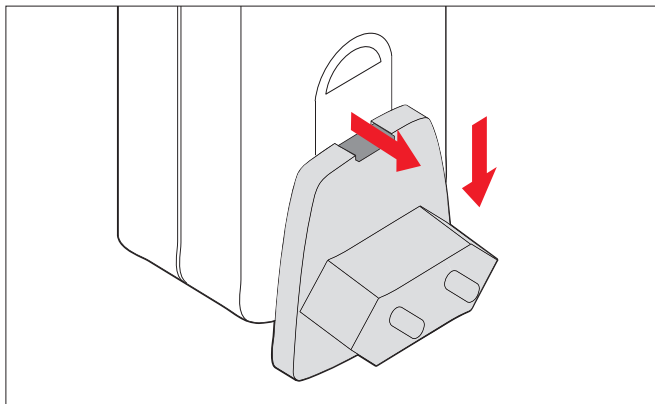

1. Insert the appropriate plug for the local mains power supply into the charger.  
To do this, push up  
a. the release button and at the same time push  
b. the plug down out of its engaged position.
2. It can then be removed completely downwards.
3. Push the appropriate plug variant into the charger from below until it engages.

### for use in the USA

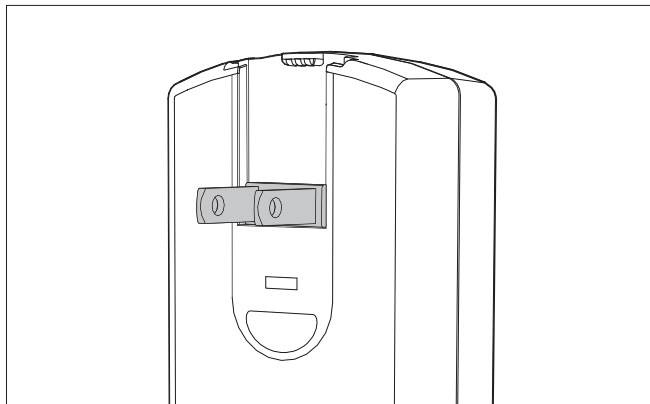

1. Remove the mains plug fitted at the factory from the charger. To do this, push up  
a. the release button and at the same time push  
b. the plug up out of its engaged position.
2. The two pins of the USA plug that are normally horizontal when not in use can then be folded out.

#### Notes:

The charger switches automatically to the prevailing mains voltage. In combination with the car charging cable supplied with the charger, it can be used in all vehicles with 12 V and 24 V power systems. In this case again, it switches over automatically.

## CONNECTION OF THE CHARGER

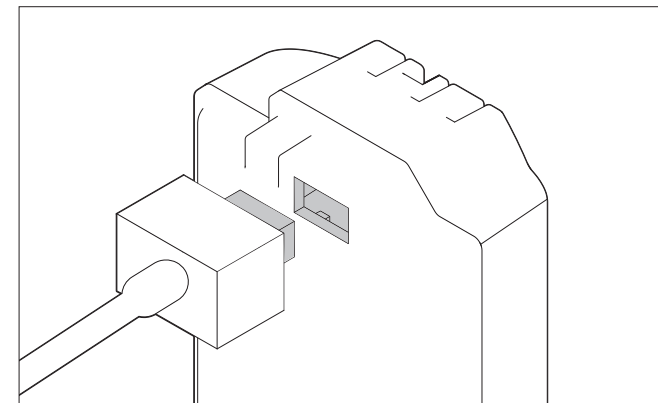

1. Connect up the charger, i.e. insert its cable plug into the socket of the battery and insert the mains plug into a plug socket.
  - The green LED marked **CHARGE** then starts to flash as confirmation that charging is in progress.
  - As soon as the battery has charged to at least  $\frac{1}{4}$  of its capacity, the orange LED marked 80% also lights up.
  - When the battery has been completely charged after approx. 3½ hours, 100% capacity has been reached, the flashing green **CHARGE** LED changes to a steady light.

#### Notes:

- The 80% LED lights up after around 2 hours due to the charging characteristics. If the full capacity of the battery is not absolutely necessary, the camera can be ready for use again in a relatively short time.
  - The steady light of the green CHARGE LED indicates that the charger has automatically switched to trickle charging.
2. The charger should then be disconnected from the mains power supply. There is, however, no risk of overcharging.

## CHANGING THE BATTERY

### Preparations

Turn off the camera, i.e. set the main switch to **OFF**.

### Insertion

Push the battery with the contacts facing forward and with its guide groove facing the middle of the camera fully into the battery compartment. It engages automatically in this position.

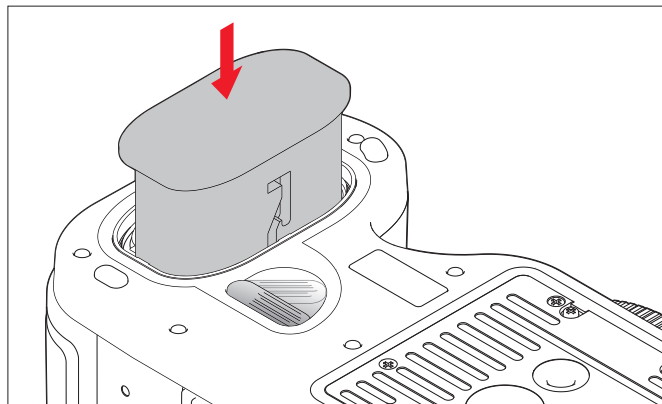

### Removal

1. Turn the release lever in clockwise direction until it stops
  - A spring in the battery compartment then pushes the battery approx. 1 cm out.
  - The locking mechanism has a detent so that the battery cannot accidentally fall out even if the camera is held upright.
2. Push the battery approx. 1 mm back to disengage the detent, and
3. then pull it out of the compartment or, if the camera is held upright, allow the battery to slide out into your hand.

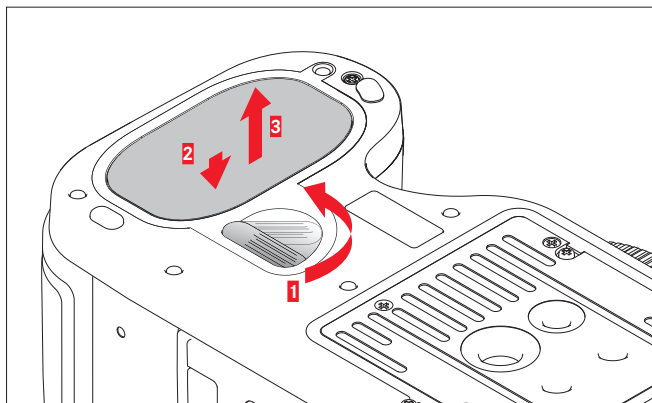

2. Open the cover on the right-hand side of the camera, i.e. push back slightly to unlock, then fold open to the right.

### Note:

Do not touch the memory card contacts.

## CF cards (CompactFlash)

### Insertion

Push the card with the contacts facing towards the camera and with the front facing towards the front of the camera fully into the slot.

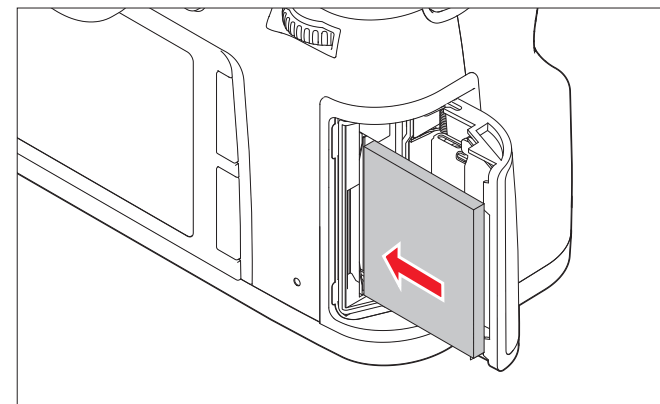

### Note:

Ensure that the ejection slide is completely pushed in (see "Removal" on the following page).

### Important:

Do not use force! The contacts in the card slot could otherwise be damaged!

## CHARGE LEVEL DISPLAYS

Monitor	Top panel display	Charge status
		approx. ≥ 85%
		approx. ≥ 65%
		approx. ≥ 40%
		approx. ≥ 20%
		approx. ≥ 5%
		approx. ≤ 5%, replacement or recharging of the battery necessary

## CHANGING MEMORY CARDS

The Leica S offers you the possibility of using 2 card types in parallel for storing of recorded data. It has two card slots, one for SD/SDHC/SDXC (Secure Digital) cards and one for CF (Compact Flash up to UDMA 7) cards.

### Preparations

1. Turn off the camera, i.e. set the main switch to **OFF**.

### Note:

Do not turn off the camera as long as the LED for data storage is still lit.

**Removal**

1. Push the ejection slide inwards.
  - The slide is then pushed out slightly.
2. Press the slide inwards again.
  - The card is then pushed slightly out of the slot.
3. Pull out the card.

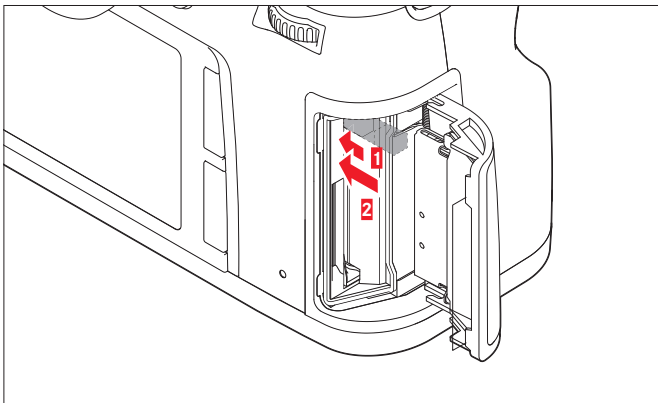
**SD / SDHC / SDXC cards****Insertion**

Push the card completely into the slot with the contacts facing to the rear and with the beveled corner facing upwards against the spring pressure until it engages audibly.

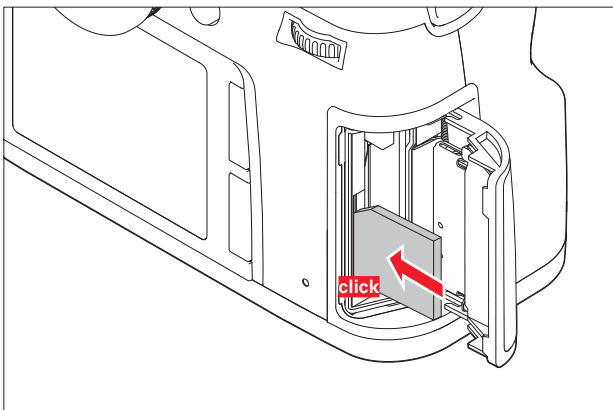
**Important:**

Ensure that no SD/SDHC/SDXC card is pushed into the CF card slot as it might not be possible to remove it again!

**Removal**

1. Press the card further into the slot.
  - The card is released and pushed slightly out of the slot.
2. Pull out the card.

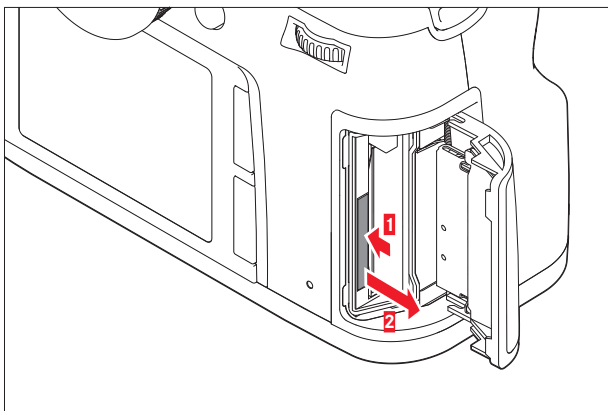
**Close cover**

Close the cover and push forward until it engages.

**Displays**

Memory card faults are indicated by different messages in the viewfinder, monitor and top panel display.

**Notes:**

- If the memory cards cannot be inserted, check that they are aligned correctly.
- The range of memory cards available is too large for Leica Camera AG to be able to completely test all available types for compatibility and quality. Although using other card types is not likely to damage the camera or the card, some "no name" cards do not comply with the memory card standards, and Leica Camera AG is unable to provide any guarantee that they will function correctly.
- Do not remove either a memory card or the battery as long as the red LED at the bottom right next to the monitor is flashing, indicating picture recording and/or data saving to the card(s). Otherwise the unsaved (or not completely saved) picture data may be lost.
- The Leica S offers different variants for the storage of picture data. Further information on this topic can be found under "Storage of picture data / memory card management".
- As electromagnetic fields, electrostatic charges, and defects in the camera or the card(s) can lead to damage or loss of the data on the memory card(s), we recommend that you also transfer the data to a computer and save it there.
- For the same reason we also recommend that the cards are always stored in an antistatic case.
- The proper function of the camera cannot be guaranteed if WiFi cards are used.
- SD, SDHC, and SDXC memory cards have a write protection switch, which can be used to prevent unintentional storage and deletion of pictures. This switch takes the form of a slider on the non-beveled side of the card; in the lower position, marked LOCK, the data is protected.
- Memory cards with a capacity of less than 1 GB cannot be used.

## CHANGING THE FOCUSING SCREEN

The Leica S allows the focusing screen to be changed (see also "System accessories / Interchangeable focusing screens". As standard the camera is supplied with a completely matt screen. The other focusing screens are delivered individually in a case with tweezers and a dust brush.

To change the screen

1. Remove the lens, and

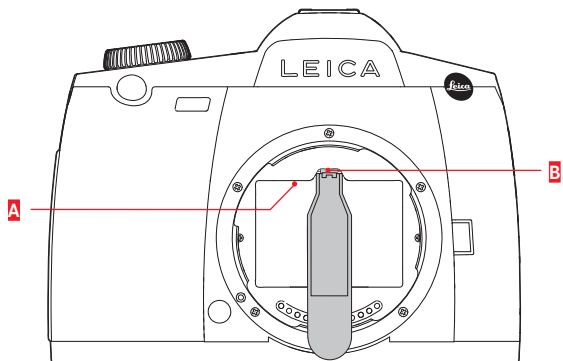

2. Release the screen frame **A** from its engaged position by pressing the tab **B** with the tip of the tweezers.

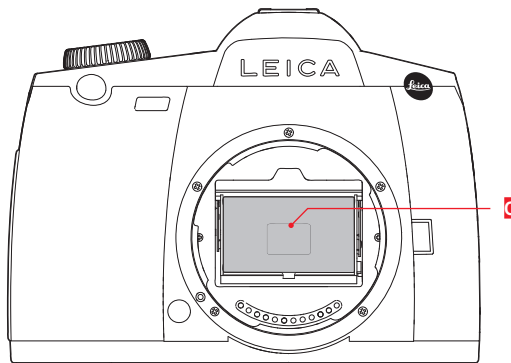

3. Then grip the focusing screen **C** at the small tab using the tweezers, tilt it forwards slightly and remove.
4. Then place the screen temporarily into the side compartment of the case.

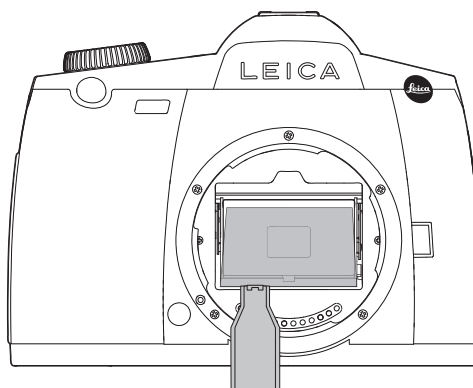

5. Grip the screen to be installed with the tweezers at its tab, place into the frame and
6. press the frame upwards into its engaged position with the tip of the tweezers.

### Important:

Proceed exactly as described above when changing the screen. Take particular care to protect the delicate surfaces of the focusing screens from scratches.

## LEICA S LENSES

Leica S lenses have a number of characteristic features:

- The focusing ring functions differently, depending on the set focus operating mode:
- In manual mode (MF), the focus is set in the normal way by turning the ring - in this case it is already mechanically linked to the lens construction.
- In autofocus mode (AFs/AFc) it is initially disconnected - so that holding the lens at the ring does not hinder the motorized adjustment. However, you can "override" the automatic setting at any time, i.e. set the focus manually even during AF mode. In this case the ring is immediately linked to the lens construction as soon as it is turned.
- The internal range scale can be read off through a window.
- They have no aperture setting ring. The aperture is set using the thumbwheel on the camera body.

### Note:

- Some Leica S lenses are also available with integral central shutter.
- Leica Camera AG manufactures its products to the highest standards of quality. In order to ensure their perfect function, extensive calibration and testing steps are necessary during the production process. For this purpose the camera is connected to different testing devices several times. These important production steps can create minor shiny spots on the stainless steel bayonet ring. This is not a quality defect and merely documents the stringent testing of your Leica S.

## FITTING AND REMOVING THE LENS

All lenses and accessories with Leica S bayonet can be fitted to the Leica S.

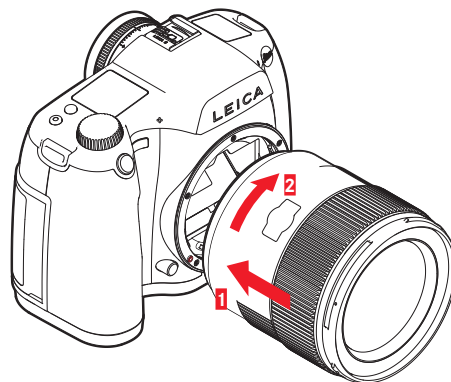

### Fitting

1. Align the red dot on the lens mount with the button of the bayonet release on the camera body
2. In this position, insert the lens straight
3. Turning completely to the right causes the lens to engage audibly and tangibly

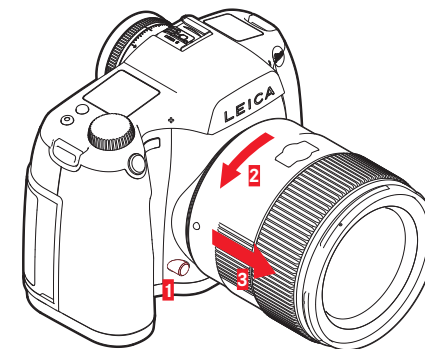

### Removing

1. Press the release button
2. Release the lens by turning in anti-clockwise direction
3. Remove the lens in a straight line

### Notes:

- To prevent the ingress of dust etc. into the interior of the camera, and in particular to keep the sensor surface free from dust, it is important to always have a lens or a cover fitted to the camera body.
- For the same reason, when changing lenses work quickly and in an environment that is as dust-free as possible.
- Leica also carries out firmware updates for lenses at irregular intervals. You can download new firmware from our website easily yourself to your lens. Further information can be found under "Installing firmware updates".

### ADJUSTING THE EYEPIECE

The viewfinder can be adjusted from -3 to +1 diopters to adapt it exactly to your own eyesight. To do this, turn the knurled ring while observing the viewfinder image until the borders of the selective metering field are sharply focused.

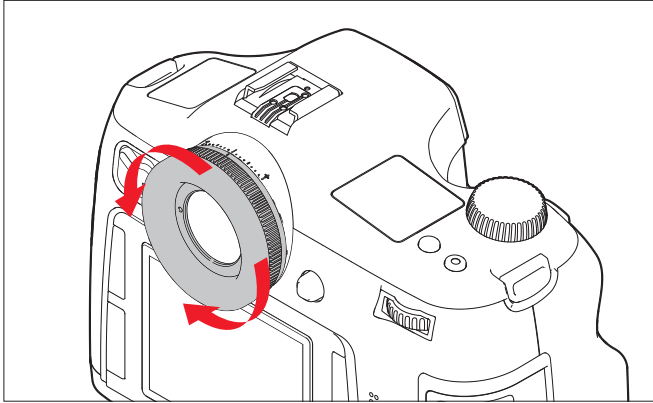

#### Note:

If you are not looking through the viewfinder, e.g. during recordings with a tripod, we recommend that the eyepiece cover is fitted. This prevents any influencing of the exposure metering. The cover can be stored on the carrying strap.

### TURNING THE CAMERA ON AND OFF

The Leica S is turned ON and OFF using the main switch. It has three stop positions:

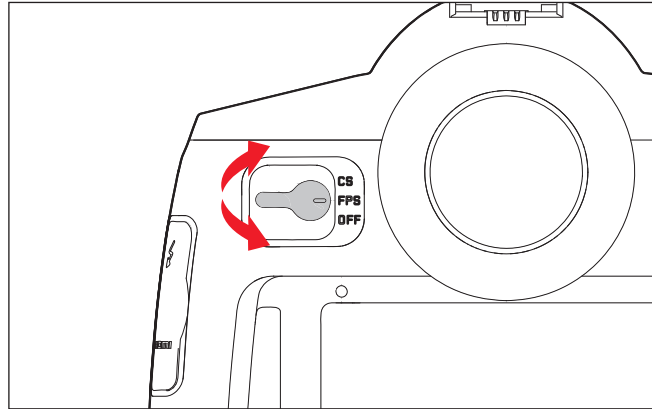

a. **OFF** – Camera turned off

b. **FPS** – Camera turned on, focal plane shutter in body in operation  
– The shutter speed is controlled via the focal plane shutter in the camera. All speeds are available (see also "Shutter speed setting dial").

c. **CS** – Camera turned on, central shutter in (correspondingly equipped) lens in operation  
– The shutter speed is controlled via the central shutter in the lens. Speeds of  $8\text{-}\frac{1}{1000}$  s are available (see also "Shutter speed setting dial").

#### Note:

Even when set to **CS**, the camera operates with the focal plane shutter when

- A lens without central shutter is fitted, and/or shutter speeds of more than 8 s, or
- less than  $\frac{1}{1000}$  s are set.

After turning on, i.e. after selecting one of the two functions **FPS** or **CS**, the LED at the bottom right next to the monitor lights up until the camera is ready (2 s) and the displays appear in the viewfinder and in the top panel display.

#### Notes:

- Even if the main switch is not set to OFF, the camera is automatically turned off if an automatic power off time has been set in the menu and none of the controls are used in this time.
- When the camera is turned off, running functions, i.e. bracketing and self-timer operation, are aborted and also deactivated in the respective menus.

## MENU CONTROL

Most of the operating modes and settings of the Leica S are operated by a menu control. Navigation and settings in the whole menu are very quick and simple as

- the menu items are divided into function groups, and
- also five user-defined menu items can be called up directly by holding the button depressed (quick access).

### Controls / calling up menu control

Three of the four buttons to the left and right of the monitor are used for calling up menu control and for direct access to the function groups, namely the two buttons on the left and the lower right button.

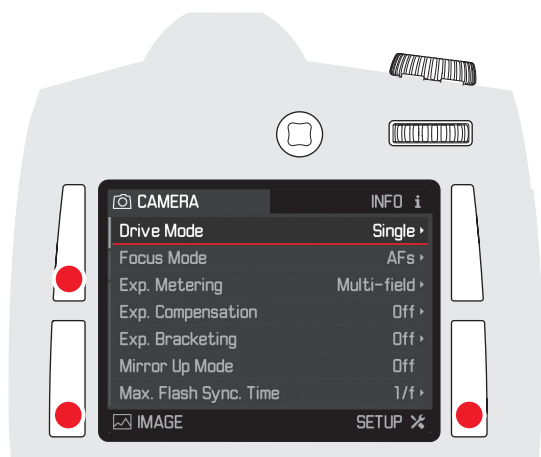

### Note:

All four of these buttons are "soft keys". Outside menu control, e.g. in Live View and video mode and during the review of pictures on the monitor, they have different functions that are indicated by corresponding displays.

All settings of the menu items can also be made with the rear thumb-wheel or the Joystick.

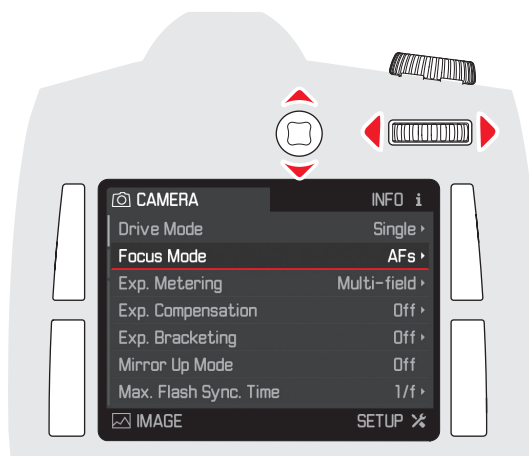

### Exiting the menu

You can exit the menu in different ways:

- To switch to recording mode:  
Press the shutter release or video record button, or press the Live View button
- To switch to the recorded data display:  
Press the button top right - in this case marked **INFO** - briefly
- To switch to review mode:  
Press the button top right while the recorded data are displayed - in this case marked **PLAY** - briefly again

## MENU FUNCTION GROUPS



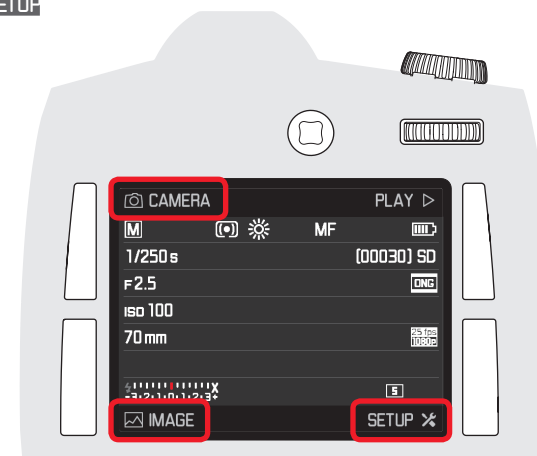

The menu of the Leica S is divided into 3 function groups (see Annex "The menu items"):

- **CAMERA**
- **IMAGE**
- **SETUP**





## Navigating in the menu / setting the functions

1. Select the respective menu function groups by briefly ( $\leq 1$  s) pressing the following buttons twice:
  - Top left for the menu items of the **CAMERA** function group,
  - Bottom left for the menu items of the **IMAGE** function group, and
  - Bottom right for the menu items of the **SETUP** function group.
  - If the monitor was previously inactive (dark), the recorded data display appears when the button is pressed briefly the first time. The text boxes in the monitor image opposite the three buttons indicate the corresponding menu function groups.
  - If these are displayed from review mode, the button functions valid in this situation are first displayed in an intermediate step:
    - Top left:  (Menu)
    - Bottom left:  (Delete)
    - Top right:  (Protect)
    - Bottom right:  (Recorded data display)

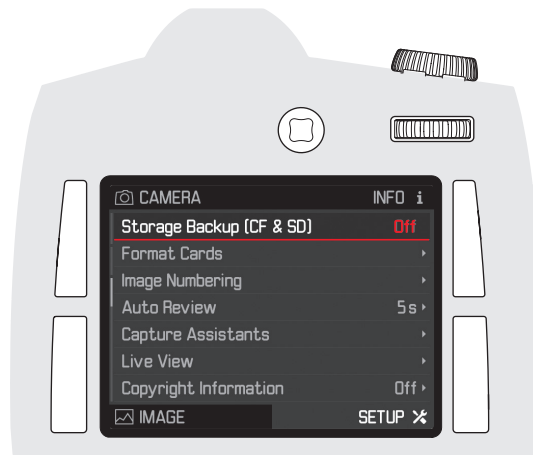
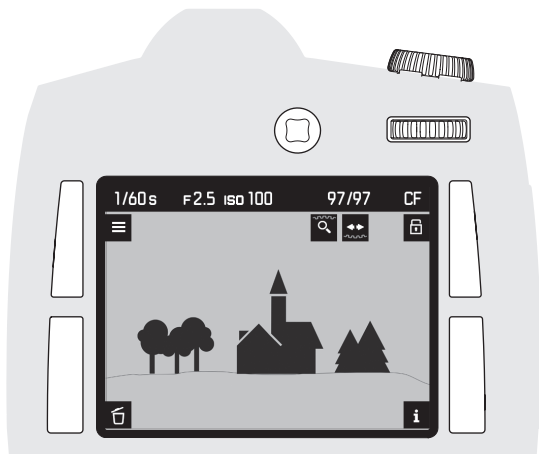

- The menu screen shows as a guide to orientation:
  - In white type the respective menu function group selected
  - In group **SETUP**, with a scrollbar on the left, which page of the list is currently displayed
  - On each page in the individual lines the menu items are displayed on the left and to the right the corresponding settings.
  - In white type with red underlining the active menu function line (this applies at all menu levels). The currently set function variant or the currently set value is always displayed to the right in the line.When the menu is called up, the last menu item changed is always active.

2. Select the individual menu items
  - either by turning the rear thumbwheel to the right = scroll down / to the left = scroll up,
  - or by pressing the Joystick in the desired direction.The menu items of all three function groups form a common endless loop, i.e. they can all be reached in both directions.

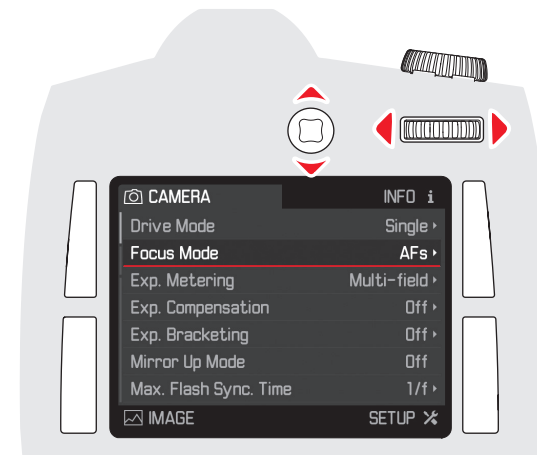

### Direct setting of the menu items without sub-menu

(In the 4 menu items without a triangle at the right-hand end of the line)

- Press the rear thumbwheel or the Joystick forwards or to the right
  - The set function variant changes. The setting is immediately active, i.e. it does not have to be confirmed.

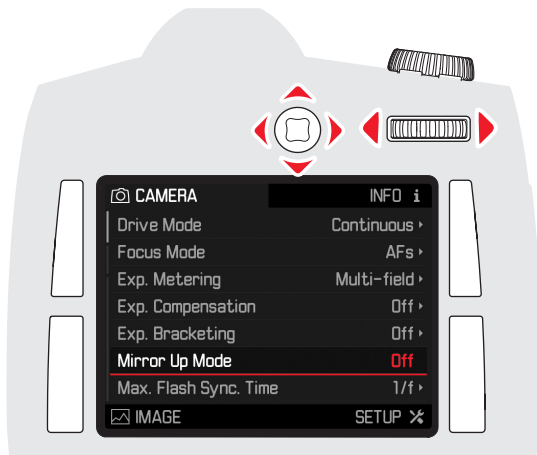

### Further setting of the menu items with sub-menu

- Press the rear thumbwheel or the Joystick forwards or to the right to call up the list of the respective function variants
  - The sub-menu in which the respective function variant or the values that can be set appears.

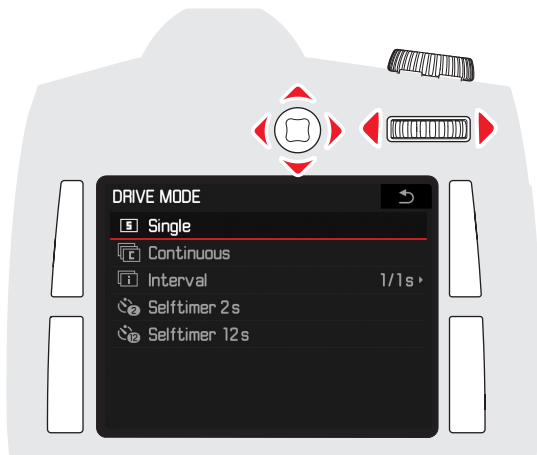

- Turn the rear thumbwheel to the right or left or press the Joystick in the desired direction (this differs, depending on whether a list or a

scale is displayed) to select the desired function variant / the desired value

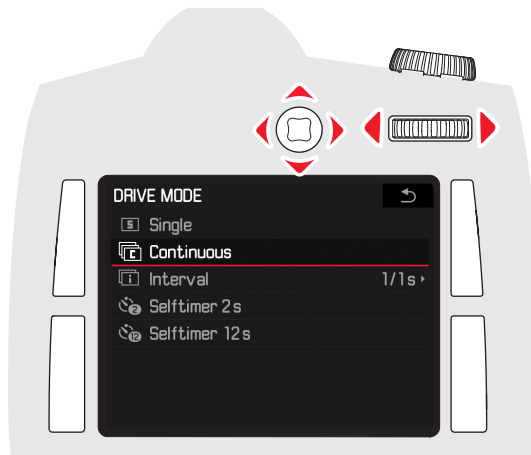

- Press the rear thumbwheel or the Joystick forwards to confirm the set function variant / the set value
  - The display returns to the next higher menu level or switches to the next function variant for functions requiring further settings.

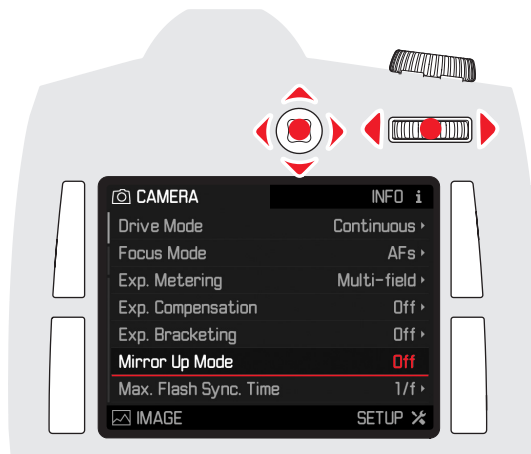

### Note:

Briefly pressing the button marked  in this case allows you to return to the menu at any time – without saving the changes made in the sub-menus up to that point.

### Quick access to menu functions

For particularly fast operation you can use all four buttons and, in normal photo recording mode, also the depth of field preview button to directly call up as many as 5 of the menu functions most important to you or the most frequently required menu functions.

First define which (menu) function you wish to call up with each of these buttons.

### Note:

The buttons for the quick access are assigned as follows at the factory:

Button top left: **ISO**

Button bottom left: **Exp. metering**

Button top right: **Focus mode**

Button bottom right: **Exp. compensation**

Depth of field preview button:

- In normal photo recording mode: Depth of field preview
- In Live View mode: Depth of field preview plus exposure simulation
- In video mode: Access to setting the audio recording level and the headphone volume.

The functions of the depth of field preview button cannot be changed in Live View and video mode.

### Setting the function / customizing the buttons

- In the menu, under **SETUP**, select the item **Customize Controls**
  - A sub-menu appears with the three items **Customize Controls**, **AF/ AE Lock Button** and **Rear Wheel Direction**.

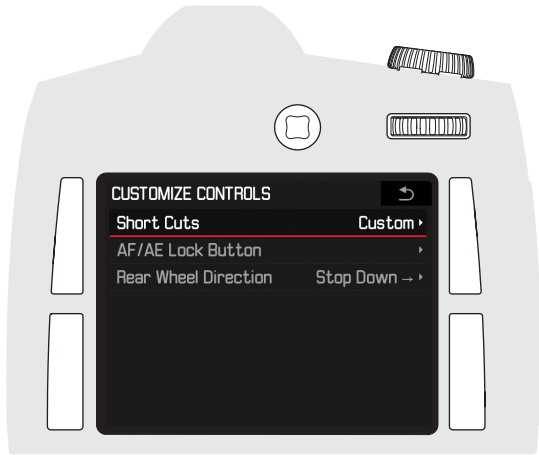

- In this sub-menu, select **Customize Controls**
  - A further sub-menu appears. If **Customize Controls** is not set to **Custom**, all the other items are inactive.

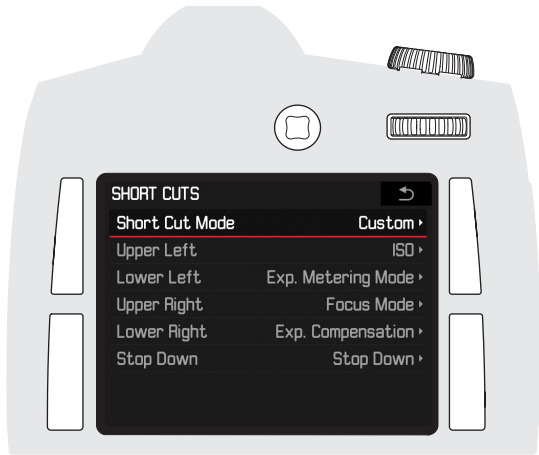

- In this sub-menu, select **Customize Controls**
  - A further sub-menu appears.

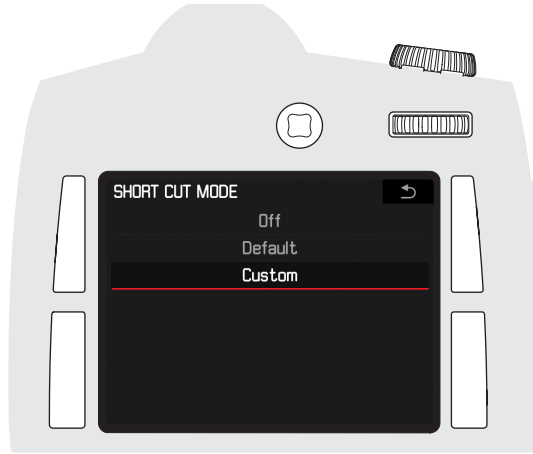

- In this sub-menu, select **Custom**
  - (or **Default** if the factory setting of the button functions is to be used, or **Off** if the function is to be deactivated)
    - The menu displayed in step 2. appears again.
- In the **Custom** sub-menu, select the desired button
  - A list with the available menu functions is displayed.

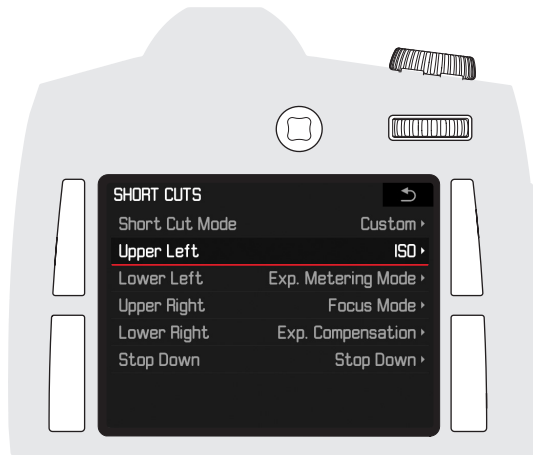

- In the respective sub-menu, select the function you wish to call up or execute directly in future with the button selected in step 5, or **Off** if you do not wish to assign a quick access to this button

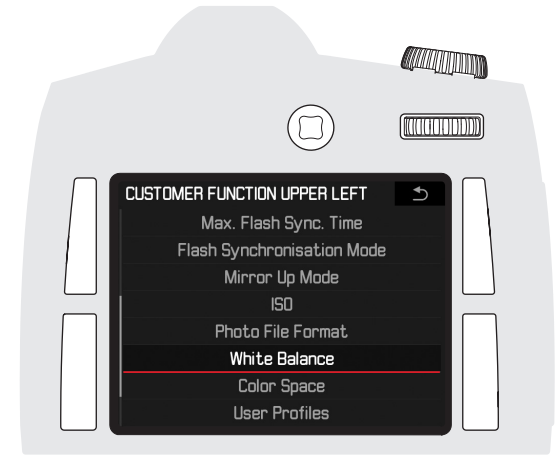

- The other buttons are customized in the same way.
- The menu displayed in step 2. then appears again.

### Calling up the selected menu functions

You can then call up or execute the respective set (menu) functions directly at any time and make further settings there:  
 Hold the buttons alongside the monitor pressed ( $\geq 1$  s), or in normal photo recording mode press the depth of field preview button

#### Note:

In Live View (photo) and video mode the depth of field preview button is assigned other functions, i.e. the quick access function that may have been set is not available in these modes. After exiting the respective operating mode, the depth of field preview button has the previously assigned function again.

## PRESETS

### CAMERA DEFAULT SETTINGS

#### Menu language

The language used in the default setting of the menu control is English. **German**, **French**, **Italian**, **Spanish**, **Russian**, **Japanese**, **Chinese Trad.**, **Chinese Simp.**, **Korean** and **Portuguese** can also be selected as alternative menu languages.

#### Setting the function

1. In the menu, under **SETUP**, select the item **Language** and
2. select the desired language in the sub-menu.
  - Apart from a few exceptions (button names, short designations), all linguistic information changes.

### Date and time

#### Date

There are 3 options available for the sequence of the date.

#### Setting the function

1. In the menu, under **SETUP**, select the item **Date & Time** and
2. call up the sub-menu
3. Select **Date Setting** and call up the corresponding sub-menu
4. To change the representation, **Day/Month/Year**, **Month/Day/Year**, or **Year/Month/Day**, press the Joystick up or down or turn the rear thumbwheel with the header line active.
5. Pressing the Joystick to the left or right takes you out of the marked header line to the three setting fields below, or back to the header line.
6. In the respective marked setting field, make the settings by pressing the Joystick up or down or by turning the rear thumbwheel.
7. Confirm and save the settings by pressing the button marked **OK** in this case at the bottom right next to the monitor

### Time

#### Setting the function

In sub-menu item **Time Setting** the settings are made for both the numerical groups and for the representation in essentially the same way as described in the previous section for the date.

Of the other three items in the **Date & Time** sub-menu, **Auto GPS Time** and **Daylight Saving Time** are activated or deactivated by pressing the rear thumbwheel or the Joystick forward or to the right, while under **Time Zone** the desired location is selected from the list in the corresponding menu by turning the rear thumbwheel or pressing the Joystick up or down.

#### Notes:

- **Auto GPS Time** is only available when the GPS function is switched **on**, **Time Zone** and **Daylight Saving Time** are only available when the GPS function is switched **off**.
- Even if no battery is inserted or the battery is discharged, the date and time settings are retained for roughly three months by an integrated back-up battery (see also "Charge level displays"). After that period, however, the date and time must be set again as described above.

#### Auto power OFF

This function turns the camera off automatically after a preset time. This state corresponds to the main switch position **Off**.

#### Setting the function

1. In the menu, under **SETUP**, select the item **Auto Power Saving** and
2. set the desired time

#### Note:

Even if the camera is in standby mode, i.e. the displays have gone out or the activated **Auto Power Saving** function has turned it off, it can be reactivated at any time by pressing the shutter button.

## Signal tones

With the Leica S you can decide whether messages or autofocus mode should be confirmed by acoustic signals, or whether the camera operation should be more or less silent. Two volumes can be selected. The feedback is a beep tone that can be activated separately for autofocus mode to indicate the completed setting and as a signal for a message or warning.

### Note:

In the factory setting the signal tones are deactivated.

## Setting the functions

1. In the menu, under **SETUP**, select the item **Acoustic Signals** and
2. call up the sub-menu  
It consists of the 3 items **Volume**, **AF Confirmation** and **Warnings**.
3. Under volume select **Low** or **High**
4. In the other sub-menus select whether or not you wish to activate the tones for the respective functions

### If you select **On**

With AF confirmation a signal sounds as soon as the focus – whether automatic or manual – is set correctly, i.e. together with the lighting up of the corresponding display in the viewfinder.

With **Warnings** a signal sounds together with all messages and warnings displayed in the monitor, and on expiry of the self-timer.

### If you select **Off** for **Warnings**

Even if you select **Off**, an acoustic warning signal is nevertheless given in two situations:

- If the cover over the memory card slots is opened during data transfer
- When the shutter closes again at the end of the sensor cleaning process

## Monitor and top panel display

The Leica S has two displays,

- a black-and-white liquid-crystal display, and
- a large 3" liquid-crystal color monitor that is protected by a hard and therefore very scratch-resistant glass cover.

The top panel display shows i.a. the most important basic information on the status of the memory card(s) and the battery, and on the exposure control (see "Displays in the top panel display", p. 61).

The monitor shows the complete image field, along with the selected data and information (see "Displays in the monitor", p. 62ff). The brightness of the monitor is controlled automatically, depending on the ambient brightness. The sensor above the monitor is used for this function. Furthermore, its basic brightness can be adapted to the respective situation or to your personal wishes.

### Setting the functions

1. In the menu, under **SETUP**, select the item **Display Brightness** and
2. select the desired setting in the sub-menu

## Monitor



## Top panel display



## PICTURE DEFAULT SETTINGS

### PHOTO FILE FORMAT

Two file formats, DNG and JPEG, are available for recording the picture data for photos. You can choose whether your picture data are to be saved

- a. in just one of these formats, or
- b. simultaneously in both formats (i.e. two files are always created per picture).

#### Setting the function

1. In the menu, under **IMAGE**, select the item **Photo File Format** and
2. select the desired format(s) or combination in the sub-menu

#### Notes:

- The standardized DNG (Digital Negative) format is used for storage of raw picture data.
- The remaining number of pictures shown in the monitor may not necessarily change after every picture. This depends on the subject; with JPEG files very fine structures result in higher quantities of data, homogeneous surfaces in lower quantities. As a result the remaining memory capacity may be larger than previously calculated and displayed.

## JPEG SETTINGS

### Resolution

Whereas the full resolution of 37.5 MP is always used in DNG format, two lower resolutions can also be used with the JPEG format.

#### Setting the function

1. In the menu, under **IMAGE**, select the item **JPG Resolution** and
2. select **37.5MP**, **9.3MP** or **2.3MP** in the sub-menu<sup>1</sup>

### Working color range

The Leica S allows one of three color ranges to be set, i.e. **sRGB**, **AdobeRGB** or **ECI RGB 2.0**.

#### Setting the function

1. In the menu, under **IMAGE**, select the item **JPG Settings**
2. then the menu item **Color Space**, and
3. select the desired color range in the sub-menu

### Picture properties / contrast, sharpness, color saturation

All three picture properties can be set – independently – to three different levels (with color saturation four) using the menu control, so that you can set the optimum values for any situation, i.e. the prevailing lighting conditions. In the case of **Saturation**, **Monochrome** can also be selected as a fourth variant.

#### Setting the functions











1. In the menu, under **CAMERA**, select the item **JPG Settings** and
2. call up the sub-menu
3. In this sub-menu select **Contrast**, or **Sharpness**, or **Saturation**, and
4. select the desired level (**Low**, **Medium**, **High** or **Monochrome**) in the respective sub-menu

## WHITE BALANCE

In digital photography, white balance ensures neutral rendition of color in any light. It is based on the camera being preset to reproduce a particular light color as white. In the Leica S you can select between twelve different settings:

- **AWB** (Auto) – for automatic control, which delivers neutral results in most situations,

Eight fixed presets for the most frequent light sources:

-  e.g. for outdoor pictures in sunshine,
-  e.g. for outdoor pictures with cloudy skies,
-  e.g. for outdoor pictures with the main subject in shadow,
-  e.g. for indoor pictures with (predominantly) incandescent lamp light
-  e.g. for indoor pictures with (predominantly) light from metal halide lamps (HMI)
-  e.g. for (predominantly) light from fluorescent tubes with warm light color
-  e.g. for (predominantly) light from fluorescent tubes with cooler light color
-  e.g. for pictures with (predominantly) electronic flash lighting,
- Two **Greycard** settings for manual setting by metering (separately for the Live View  and the normal photo mode 
- **K** **Color Temperature**<sup>1</sup> – for direct setting of a color temperature value.

#### Note:

Setting to **Automatic** allows the white balance to be adjusted for correct color reproduction when using Leica system flash units or electronic flash units that satisfy the technical requirements of System 3002 System Camera Adaption (SCA) and have an SCA-3502 adapter (from Version 5). If, on the other hand, other flash units not specially adapted to the Leica S are used, the setting  should be used.

<sup>1</sup> All color temperatures are specified in Kelvin.

## Setting the function

### Automatic and fixed settings

1. In the menu, under **IMAGE**, select the item **White Balance** and
2. select the desired function in the sub-menu

### Direct color temperature setting

You can directly set values between 2000 and 13100 (K<sup>1</sup>) (from 2000 to 5000K in increments of 100, from 5000 to 8000K in increments of 200 and from 8000 to 13,100K in increments of 300). This provides you with a broad scope, covering most of the color temperatures occurring in practice and within which you can adapt the color reproduction to the prevailing light color and/or your personal preferences.





1. In the menu, under **IMAGE**, select the item **White Balance**,
2. in the sub-menu select the variant **Color Temperature**, and
  - A further sub-menu appears with a list in which the value to be set is indicated by the red border.
3. select the desired value there.

### Manual setting by metering

1. In the menu, under **IMAGE**, select the item **White Balance** and
2. select the desired greycard variant in the sub-menu

The further procedure differs, depending on the greycard variant.



If you have selected the normal photo mode .

- The message **Please take a picture for setting the white balance** appears in the monitor.
3. Take the picture, making sure that the image field contains a white or neutral gray (reference) surface.
    - The monitor shows
      - the image based on the automatic white balance setting,
      - cross hairs in the center of the image.
      - the button functions  and  valid in this situation
  4. Press the Joystick in the desired direction to move the cross hairs to the subject detail you want to use as the basis for the new white balance setting (e.g. the reference surface mentioned above)
  5. Press the button alongside the  display, or press the Joystick forward.
    - The color reproduction of the picture is adapted accordingly and the button function  valid in this situation is also displayed.
  6. You can now either
    - either accept this new white balance setting - by pressing the button alongside the  display,
    - The message **White balance is set** appears in the monitor.
    - or make any number of further settings, as described under 3. - 6.
      - The message described under 3. appears each time in the monitor.

If you have selected the Live View photo mode .

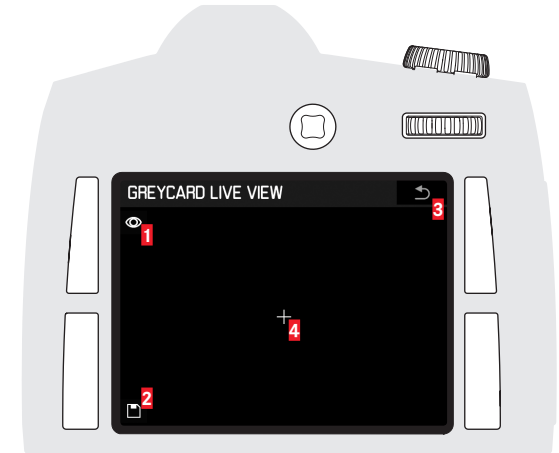
- The corresponding screen appears in the monitor.



- 1 Indication of button function: Perform white balance metering
  - 2 Indication of button function: Save white balance metering (active only after metering)
  - 3 Indication of button function: Back to normal photo mode (without saving any metered value)
  - 4 Display of the metering field
3. Move the metering field to a white or neutral gray subject detail by pressing the Joystick in the desired direction
  4. Carry out metering by pressing the  button at top left next to the monitor, or by pressing the Joystick forward
  5. Save the metered value by pressing the  button at bottom left next to the monitor
    - The camera switches back to the normal photo mode and the monitor image disappears.

### Notes:

- The corresponding picture is always saved parallel to a saved white balance setting.
- A value set in this way remains saved for and will be used for all pictures until it is superseded by a new metered value or you use one of the other white balance settings.

## ISO sensitivity

The ISO setting on the Leica S allows a manual adjustment of the shutter speed/aperture values to the needs of the particular situation.

As well as the fixed settings, the Leica S also features the **ISO Auto**<sup>1</sup> function, in which the camera automatically adjusts the sensitivity to the ambient brightness. When using the function, however, it is also possible to specify priorities, for example for compositional reasons. You can both limit the range of sensitivities used and set the shutter speed below which the sensitivity is automatically increased.

### Notes:

A general rule of thumb in digital photography is that higher sensitivities result in increased noise. This has to be taken into consideration for the expectations on the picture quality.

Note with picture series that the frame rates decrease with higher sensitivities.

### Setting the function

1. In the menu, under **IMAGE**, select the item **ISO** and
2. call up the sub-menu  
It consists of the available ISO values and the point **ISO Auto**.

### If you wish to set the sensitivity manually

3. select the desired value

### If the sensitivity setting is to function automatically and without limitations

4. select **ISO Auto**.  
The automatic setting uses all sensitivities and shutter speeds between  $\frac{1}{2}$  s and  $\frac{1}{600}$ s

### To restrict the automatic setting range

1. In the menu, under **SETUP**, select the item **Auto ISO Setup** and
2. select **Auto ISO Photo** in the sub-menu

3. Select **Maximum Auto ISO** and/or **Maximum Exposure Time**
  - When setting **Maximum Auto ISO**, a list with the available values appears, when setting **Maximum Exposure Time** a further sub-menu with several alternatives.
4. In the **Maximum AUTO ISO** menu list, select the highest sensitivity to be used, and hence the range within which the automatic setting is to operate, or in the **Maximum Exposure Time** sub-menu set either one of the three focal length-specific settings -  $\frac{1}{f}$ ,  $\frac{1}{2f}$ ,  $\frac{1}{4f}$  or the desired slowest shutter speed. With the  $\frac{1}{f}$  settings the camera switches to the higher sensitivity if the shutter speed would drop below the selected threshold due to a lack of brightness, e.g. with a 70 mm lens with shutter speeds lower than  $\frac{1}{60}$ s (with  $\frac{1}{f}$  (f=focal length)), or  $\frac{1}{125}$ s with  $\frac{1}{2f}$ , or  $\frac{1}{250}$ s with  $\frac{1}{4f}$  \*.

### Note:

The factory setting of  $\frac{1}{2f}$  results in the slowest shutter speeds according to the rule of thumb adapted for this format for blur-free pictures taken from the hand, e.g.  $\frac{1}{125}$ s with the Summarit-S 1:2.5/70mm ASPH lens. The corresponding shutter speeds with  $\frac{1}{2f}$  and  $\frac{1}{4f}$  in this example would be  $\frac{1}{60}$ s and  $\frac{1}{250}$ s.

<sup>1</sup> The function is not available when using flash units.



### Storage of picture data / memory card management

If two memory cards are used, you have the possibility with the Leica S to choose

- whether the picture data should first be stored on one of the two cards until its capacity is reached, and then on the other card, or whether the data should
- always be stored simultaneously on both cards.

#### Setting the function

1. In the menu, under **SETUP**, select the item **Storage Backup [CF & SD]** and
2. there select **Off** or **On**

#### Note:

If **Off** is selected:

- The picture data are first stored on the SD/SDHC/SDXC card and then once its capacity is reached on the CF card. As soon as the camera is connected to a computer, it stores the picture data only in the specified folder on the computer.

If **On** is selected:

- The picture data are stored simultaneously on both cards.

With both settings:

- If only one card is used (irrespective of which), the picture data are stored there.

As soon as the camera is connected to a computer, it stores the picture data on a card and also in the specified folder on the computer.

## RECORDING MODE

### FOR PHOTOS

#### SHUTTER BUTTON

- Pressing briefly activates the range and exposure metering systems, and the displays in the viewfinder and top panel display. When the shutter button is released, the metering systems remain active for approx. 12 s.

#### Notes:

- If Review mode was previously active, the camera switches back to Recording mode when the shutter button is pressed; if it was previously in Stand-by mode, it is activated again by pressing the shutter button, i.e. the metering systems and displays are activated.
- The shutter button remains blocked
  - if the internal buffer memory is temporarily full, e.g. after a series of pictures, or
  - if the inserted memory card(s) is/are full.
- Pressing the shutter button to the pressure point and holding in this position when using Autofocus **AFc** mode (focus priority), the focus is saved at the same time. New measurements can be performed once the shutter button is released.

#### Note:

The metered exposure value during spot and center weighted metering in **A**, **T** and **F** modes is saved, if required, by (simultaneously) pressing the Joystick forwards. Automatic focusing can also be allocated to the Joystick via the menu control.

- If the button is pressed further, the photo is taken or a preselected self-timer delay time starts.

## PICTURE SERIES

With the Leica S, the picture series can be taken with a frame rate of approx. 3.5 fps.

#### Setting and using the function

- In the menu, under **CAMERA**, select the item **Drive Mode** and
- select **Continuous** in the sub-menu
- The further function is then determined by the different actuation of the shutter button:
  - Picture series are taken as long as you hold the shutter button fully depressed (and the capacity of the buffer memory and/or memory card(s) is sufficient).
  - If you only fully depress the shutter button briefly, the camera continues to take single pictures.

## INTERVAL SHOOTING

For picture series of sequences extending over a prolonged period of time, the Leica S offers interval shooting. Intervals consist of a defined total number of pictures and a defined period of time between the pictures.

#### Setting and using the function

- In the menu, under **CAMERA**, select the item **Drive Mode** and
- select **Interval** in the sub-menu
- Call up the sub-menu belonging to the interval and
- there select **Frames** or **Interval Time**
  - In both cases a further sub-menu appears with a numerical keypad. The activates field is highlighted in each case.
- Select the (first) desired digit by turning the rear thumbwheel or by pressing the Joystick up, down, to the left or to the right; in the **Frames** sub-menu for the total number of pictures, in the **Interval Time** sub-menu for the desired time interval between the individual pictures – in hours/minutes/seconds.

- To save a digit – to the line above the numerical keypad – press the rear thumbwheel or the Joystick forwards. Up to 4-digit numbers can be used; repeat steps 5. and 6. for the second, third and fourth digits. Further functions of this sub-menu:
  - ↶** (top right) = Back to the previous menu level without saving the inputs
  - OK** (bottom right) = Confirm inputs and return to the previous menu level
- Confirm your settings by pressing the button marked **SET** in this case at the bottom right next to the monitor

#### Note:

If step 7. is performed without entering a digit in the line, the camera automatically sets the numbers of the factory setting.

- Interval shooting is started by pressing the shutter button.

#### Note:

The function remains active until it is deactivated again in the menu.

#### Notes that apply equally for photo series and interval shooting:

- The camera's buffer memory allows only a limited number of pictures in series. At the pressure point of the shutter button or during a series of pictures, the number of pictures possible or still possible in the series is displayed in the viewfinder.
- Regardless of how many pictures have been taken in a series, both review modes initially show the last picture in the series or the last picture in the series saved on the currently active card, if not all of the pictures in the series have been transferred from the internal buffer memory to the respective card yet. Details of how to select the other pictures in the series and further options in review mode are described in the respective sections.

## Live View mode

Whereas the conventional photography mode presupposes use of the camera viewfinder, Live View mode permits continuous viewing of the subject on the monitor, i.e. both before and during recording.

Live View mode is switched on and off, and video mode is switched on (without starting recording) with the **LV** button. Pressing the button displays the functions in turn (in an endless loop)

Live View photo / video mode / conventional photography mode

- When switched on, the functions of the adjacent buttons are displayed for 3 seconds in the four corners of the monitor picture.
- Video mode is always performed using the monitor picture.

### Notes:

- Additional autofocus and exposure metering function variants can be used during Live View mode, see the corresponding sections.
- Live View mode is based on the image captured by the sensor. To use it, the shutter must be open and it is closed and re-cocked when the function is canceled. Of course, this is audible and may result in a delay in the shutter release.
- Frequent use of the Live View mode results in increased power consumption.

## Exposure simulation

In the factory setting, the Live View monitor picture shows the subject in the brightness resulting from the respective exposure setting. This exposure simulation allows the effect on the picture to be assessed before the photograph is taken, e.g. during exposure corrections or during manual setting of the exposure. With automatic exposure control (**P**, **A**, **T**, see p. 30/31), on the other hand, the monitor picture generally remains equally bright, i.e. within the respective setting ranges.

The exposure simulation can be deactivated by pressing the depth of field preview button so that you generally get a monitor picture with constant brightness, irrespective of the exposure settings.

The "generally" constant brightness presupposes, however, that the subject brightness and the set exposure do not result in any excessively high or low brightness values, and that the internal exposure time is not longer than  $\frac{1}{30}$ s.

## Displays in Live View mode

With the standard setting, the Live View monitor picture contains the following displays (see "The displays / In the monitor / Recording mode Live View photo", p. 62):

- In the header some fundamental information
- In the corners of the picture, symbols for the functions of the buttons alongside the monitor: = Review, = Change of display, = Magnify and = Menu
- Spot autofocus metering field (+ autofocus metering crosshair)
- Autofocus metering crosshair
- Exposure simulation
- or = Button lock

## Display settings

Repeatedly pressing the button bottom right next to the monitor calls up various additional displays/information in turn:

- Histogram and clipping indicators
- Marking of clearly focused subjects
- Grid lines and horizon
- Extended picture data
- Back to the normal view

## Histogram

The histogram depicts the brightness distribution in the picture. The horizontal axis shows the brightness values from black (left) through gray to white (right). The vertical axis corresponds to the number of pixels at each brightness level. This form of representation – together with the impression of the picture itself – provides an additional quick and easy assessment of the exposure setting.

## Clipping displays

These displays indicate the picture areas without marking.

### Setting the function

1. In the menu, under **SETUP**, select the item **Capture Assistants** and
2. select **Exposure Clipping** in the sub-menu
3. In the sub-menu select **Lower Limit** or **Upper Limit**, and
4. set the desired threshold values on the scale by turning the rear thumbwheel or by pressing the Joystick to the left or right
  - The scale shows the clipping areas relative to the overall exposure range.

The following then appears in the pictures:

- Excessively light areas are indicated in red, excessively dark areas in blue, flashing in each case. The clipping symbol ([ ]) also appears in the top right corner.

### Notes on the histogram and the clipping indicators:

- Both are available also in Review mode.
- Both always refer to the currently displayed detail (see "Enlarging the Live View monitor image").

### Marking of clearly focused subjects (focus peaking)

In Live View mode, the Leica S can mark subjects imaged with optimum focus in the monitor picture by highlighting their contours. This simplifies their recognition and hence in particular the manual setting of the focus. The three available colors permit adaptation to any background.

#### Setting the function

1. In the menu, under **SETUP**, select the item **Capture Assistants** and
2. select **Focus Peaking** in the sub-menu
3. Call up the sub-menu, and
4. select the desired color there
  - All subject details that are in focus at the set range are indicated by outlines in the selected color.

Further information on setting the focus can be found in the corresponding sections.

#### Note:

When using high ISO values and/or slow shutter speeds, the function may not work.

#### Important:

This function is based on the subject contrast, i.e. light/dark differences. Therefore, subject details that are not completely in focus but have a high contrast may also be marked.

### Grid

The Leica S offers you two variants of grid lines as an aid to picture composition.

#### Setting the function

1. In the menu, under **SETUP**, select the item **Capture Assistants**,
2. select **Grids** in the sub-menu, and
3. select **3x3** or **6x4** in the sub-menu
  - If the view with horizon and grid is selected, the selected grid is displayed in the monitor.

### Horizon

Thanks to integrated sensors, the Leica S can show their orientation both in the viewfinder and on the monitor. These displays enable you to align the camera precisely in the longitudinal and transverse axes to capture critical subjects, e.g. architecture pictures.

The corresponding display always appears in the viewfinder, on the monitor as required.

- If the view with horizon and grid is selected, a vertical scale and a horizontal bar appear in the monitor. The horizontal orientation in the longitudinal and transverse axes is indicated by a green line in the middle, deviations from the respective zero positions by red dotted lines.

#### Notes:

- The display precision is  $\leq 1^\circ$ .
- The display switches over automatically for portrait format pictures.

### Masking

In addition to the standard aspect ratio (2:3) for photos, three further ratios are available when using the DNG format: 1:1, 16:9, 2:1. They open up further composition possibilities while taking the picture.

#### Setting the function

1. In the menu, under **SETUP**, select the item **Capture Assistants**,
2. select **Photo Masks** in the sub-menu, and
3. select the desired format there
  - The monitor picture is masked accordingly, with 1:1 left and right, with 16:9 and 2:1 top and bottom. While taking the photograph the mask is transparent, during review of corresponding photos in the camera it is not.

#### Note:

Irrespective of the aspect ratio selected, the whole 2:3 image field is always recorded, i.e. the masking of the monitor picture affects only the display in the camera. Although the photo is initially displayed with the selected aspect ratio in image processing programs, it is possible to delete the masking there so that the whole 2:3 image field is available again.

### Enlarging the Live View monitor image

Select differently enlarged details:

Press the button bottom left next to the monitor repeatedly

- This gives in turn
  - Double the size
  - Four times the size
  - Back to normal size
- The buttons are not displayed with the enlarged view; a frame appears in the bottom left-hand corner that indicates the position of the detail in the picture.

Shift the detail:

Press the Joystick left, right, up or down

#### Notes:

- The grid line display is not available with the enlarged view.
- After switching Live View mode off and on again, the last displays selected are active again, but not the enlarged detail.
- Switching the camera off and on again displays the last detail selected.

## DISTANCE SETTING

With all S lenses, the Leica S offers you the choice between manual or automatic distance setting. The autofocus system determines the distance to the subject details in the middle of the image field; this area is marked with a crosshair on the focusing screen and, in Live View mode, also in the monitor.

Irrespective of the operating mode, a display in the viewfinder provides information on the respective setting:

- The left-hand triangle indicates the focus set too long (appears only in Manual mode or with manual override of the autofocus) - The middle dot shows a correct setting (is lit constantly), or if the system cannot determine the distance (flashes)
- The right-hand triangle indicates the focus set too short (appears only in Manual mode or with manual override of the autofocus) Further details on the displays can be found in the Annex under "The displays" / "In the viewfinder".

### Note:

The metering system operates passively on the basis of contrasts, i.e. differences in light/dark in the part of the subject being photographed. It is therefore dependent on a certain minimum brightness and contrast in the subject.

### Setting the operating mode

1. In the menu, under **CAMERA**, select the item **Focus Mode** and
2. select the desired option in the sub-menu

## Manual setting - MF

Turn the distance setting ring on the lens so that your subject or the most important part of the subject is fully in focus on the focusing screen or, in Live View mode, on the monitor.

- In the top panel display, the distances for the set focus (**FOCUS**), and for the front (**FRONT**) and rear (**BACK**) limits of the depth of field range are displayed when the shutter button is pressed to the pressure point.

In Live View mode you can call up an enlarged detail as a setting aid.

1. In the menu, under **SETUP**, select the item **Capture Assistants**,
2. select **Manual Focus Assist** in the sub-menu, and
3. select **On** or **Off** there
  - If the function is activated, a central detail magnified 4x is displayed briefly each time the setting ring on the lens is turned. The detail can be moved using the Joystick.

### Notes:

- Autofocus mode can be activated at any time also with manual setting of the focus using the Joystick (see next section and the section on the function of the Joystick on page 32).
- The Leica S is supplied as standard with a full matt screen with which subject details can be reliably focused sharply over the whole image field. It is suitable for most photographic fields of application and motifs. It is particularly beneficial when working with longer focal lengths and for macro photography. Further focusing screens are available as accessories which offer optimum setting conditions, depending on the field of application, and are easy to change.

## AUTOMATIC SETTING

Two autofocus modes are available. The setting procedure for both is initiated by tapping (1st pressure point) the shutter button.

### AFs (single) = focus priority

The part of the subject you are aiming at will come into focus.

- After that, the process ends and the setting is saved even if you continue to hold the shutter release button at the first pressure point.
- It is not possible to take a picture before it comes into focus, even if the shutter button is pressed all the way down.

### Note:

An AF setting can be stored not only with the shutter button, but also with the Joystick.

### AFc (continuous) = shutter release priority

The parts of the subject being photographed are fully focused.

- The process continues as long as the shutter release button is held at the first pressure point. While the button is being held down the camera's settings are corrected, so other objects at other distances may be recognized by the metering system, or if the distance to the camera of the part of the subject being photographed changes.
- A setting can only be saved by pressing the Joystick forwards.
- Even if no part of the subject is in focus, a picture can be taken at any time.

### Note:

**AFc** is not available in Live View mode.

With both AF operating modes:

You can intervene manually at any time even during autofocus mode by turning the setting ring on the lens.

- In Live View mode the color of the metering crosshair in the monitor changes from red to green when the focus has been correctly set.

### Moving the autofocus metering field in Live View mode

In Live View mode, the metering field can be moved to any point of the image field with the Joystick.

In the two enlarged details, the detail is first moved together with the metering field that remains in the middle. Only when the detail reaches the edge of the image field can the metering field be moved to the edge of the detail by pushing further.

### Note:

If Spot is used as exposure metering method in Live View mode, its metering field is coupled to that of the autofocus, i.e. both metering fields are then moved.

## EXPOSURE METERING

### EXPOSURE METERING METHODS

The Leica S offers three different exposure metering methods.

#### Setting the function

1. In the menu under **CAMERA**, select the item **Exp. Metering**, and
2. select the desired option in the sub-menu

#### Spot metering -

Only the middle of the image field is scanned and evaluated for spot metering. This area is indicated by the circle<sup>1</sup> in the center of the matt screen. In Live View mode, spot metering is linked to the autofocus metering, i.e. moving the AF metering point also affects the spot metering field.

#### Center weighted metering -

This metering method takes account of the entire image field, although the parts of the subject in the center have more influence on the exposure than the areas at the margins.

#### Multi-field metering -

This metering method is based on detection of five metered values. One is metered in a field in the middle of the image, the other four in the surrounding fields. The five metered values are used in an algorithm to calculate an exposure value appropriate to the situation, resulting in correct reproduction of the assumed main subject.

## EXPOSURE CONTROL

The four exposure modes automatic program (**P**), aperture priority (**A**), shutter speed priority (**S**) and manual exposure control (**M**) are selected on the Leica S with the rear thumbwheel:

#### Setting the operating mode

1. Hold the thumbwheel depressed ( $\geq 1$  s)
  - In the top panel display, the large letter indicating the set operating mode replaces the normal display. Triangles to the left and right indicate the further settings.
2. Turn the thumbwheel (all four operating modes can be reached in both directions)
  - The normal display appears again in the top panel display without further operating steps after a short time (approx. 2 s), or immediately if the shutter button is pressed to the pressure point. The settings of shutter speed and aperture are made by turning the rear thumbwheel and/or the shutter speed setting dial. In both cases half-steps are available.

The settings for the shutter speed (with **T** and **M**) are always made with the shutter speed setting dial, for the aperture always with the rear thumbwheel. In both cases half-steps are available.

In the factory setting, turning the rear thumbwheel to the right decreases the aperture settings, turning to the left increases the settings. This can be reversed, if desired.

#### Setting the function

1. In the menu, under **SETUP**, select the item **Customize Controls** and
2. select **Rear Wheel Direction** in the sub-menu
  - A further sub-menu appears.
3. In this sub-menu, select the desired direction of rotation

The function of both thumbwheels can be deactivated for complete protection against inadvertent changing of operating mode, shutter speed, aperture, etc., i.e. turning and pressing do not then change the settings in recording mode.

#### Setting the function

1. In the menu, under **SETUP**, select the item **Keylock** and
2. select **Off** or **On** in the sub-menu
  - If **On** is selected, the corresponding symbol appears in the top panel display, and in Live View mode also in the monitor

## AUTOMATIC PROGRAM MODE - P

Exposure time and lens aperture are automatically set according to the prevailing light and steplessly between 1/25 s and 1/4000 s, or 1/1000 s when using the central shutter on some Leica S lenses, and between open and smallest aperture of the respective lens.

Displays in viewfinder and top panel display

-  for the selected exposure operating mode, and
- the automatically controlled shutter speed and aperture values.

#### Notes:

- If the automatic sensitivity setting (**AUTO ISO**) is activated at the same time, the control range of automatic program mode is extended. Even with fully open aperture, however, the shutter speed is only extended beyond the value dictated by the 1/f<sup>1</sup> setting selected in the menu when the highest set sensitivity is reached.
- With very little light or extreme brightness it is possible that the available shutter speed range is no longer sufficient for the preselected aperture value. In such extremely rare cases a warning symbol for underexposure appears in the viewfinder (possibly also as a warning of values below the metering range, see also "Values below the metering range"), or a warning symbol for overexposure. Correct exposure metering is then no longer possible.

<sup>1</sup> The circle does not exist in all matt screen variants.

<sup>1</sup> Applies also for 1/4, 1/2f and 1/4f

## PROGRAM SHIFT

### Setting the operating mode

Select **⏏** with the rear thumbwheel

The program shift function allows the speed/aperture combinations determined in automatic program mode to be changed, while the overall exposure, i.e. the brightness of the image, remains unchanged.

The shift is performed with the shutter speed setting dial. Turn

- to the right for larger apertures (smaller values) or faster shutter speed
- to the left for smaller apertures (larger values) or slower shutter speed.

### Displays in viewfinder and top panel display, and in Live View mode also in the monitor

- **⏏** in the top panel display as an indication of the use of the Shift function, and
- the operating mode display **⏏** in the monitor changes to **⏏**.
- the automatically controlled aperture and speed values change in opposite directions.

#### Note:

Shift settings are retained

- after a photo is taken,
  - beyond the 12 s holding time of the exposure metering system, but not
  - when changing to a different exposure operating mode (**A**, **T**, **M**)
  - when the camera is switched off and on (also by **Auto Power Saving**).
- In these cases the camera always returns initially to the standard setting of shutter speed and aperture when automatic program mode is used again.

## APERTURE PRIORITY - A

### Setting the operating mode

1. Select **A** with the rear thumbwheel (see also p. 30, "Exposure control")
2. Set the desired aperture by turning the rear thumbwheel.  
The exposure time is then automatically set according to the prevailing light and steplessly between 60s and  $\frac{1}{4000}$  s, or  $\frac{1}{1000}$  s when using the central shutter on some Leica S lenses.

### Displays in viewfinder and top panel display, and in Live View mode also in the monitor

- **A** (Aperture priority) for the selected exposure mode,
- the manually set aperture value, and
- the automatically controlled time value.

#### Notes:

- If the automatic sensitivity setting (**ISO Auto**) is activated at the same time, the control range of aperture priority is extended. However, the shutter speed is only extended beyond the value dictated by the  $\frac{1}{f}$  setting selected in the menu when the highest set sensitivity is reached.
- With very little light or extreme brightness it is possible that the available shutter speed range is no longer sufficient for the preselected aperture value. In such extremely rare cases a warning symbol for underexposure appears in the viewfinder (and possibly also a warning of values below the metering range, see also "Values below the metering range"), or a warning symbol for overexposure. Correct exposure metering is then no longer possible.
- In video mode the slowest shutter speeds are dependent on the set frame rate.

## SHUTTER SPEED PRIORITY - T

### Setting the operating mode

1. Select **T** with the rear thumbwheel (see also p. 30, "Exposure control")
2. Set the desired exposure time with the shutter speed setting dial.  
The lens aperture is then automatically controlled according to the prevailing light and steplessly between open and smallest aperture of the respective lens.

### Displays in viewfinder and top panel display, and in Live View mode also in the monitor

- **T** (Time priority) for the selected exposure mode
- the automatically controlled aperture value
- the manually set time value

#### Notes:

- If the automatic sensitivity setting (**ISO Auto**) is activated at the same time, the control range of shutter speed priority is extended. A minimum shutter speed that may have been set there, however, is no longer active.
- With very little light or extreme brightness it is possible that the available aperture range of the lens used is no longer sufficient for the preselected shutter speed. If possible, select a different shutter speed.
- As a rule, however, correct exposure can be achieved with an automatic setting of the appropriate shutter speed even in such cases, by "overriding" your manual preselection. A warning symbol appears, possibly also as a warning of values below the metering range, see also "Values below the metering range". Correct exposure metering is then no longer possible.

## METERING MEMORY LOCK

The shutter button and/or the Joystick can be used to save the exposure setting (for **P**, **A** and **T**) and the automatic focus (**AF**), depending on the various menu settings.

### General notes on the storage function

#### - With the shutter button:

- Only the **AF** setting can be stored, and only in **AFs** operating mode.
- The storage function of the shutter button always applies to only one picture.

#### - With the Joystick:

- The exposure and **AF** settings can be stored. Various function combinations are available which you define via the menu control.
- The storage function of the Joystick is retained as long as it is held pressed forward, i.e. over any number of pictures, and irrespective of whether the shutter button is also pressed at the same time.
- The storage function of the Joystick applies to both the **AFs** and the **AFc** operating mode.

### Saving with the shutter button

1. Focus on the part of the subject to be metered with the crosshair<sup>1</sup> in the viewfinder
2. Press the shutter button to the first pressure point. The value stored is retained as long as this pressure point is held.
3. While holding the pressure point, determine the final picture detail and take the
4. picture.

Metering memory lock is canceled when you remove your finger from the shutter button pressure point.

### Saving with the Joystick

#### Setting the function combinations

1. In the menu, under **SETUP**, select the item **Customize Controls** and
2. select **AF/AE Lock Button** in the sub-menu
  - A further sub-menu appears.

In this sub-menu select whether you wish to set the function for **In AF Mode** or **In MF Mode** set via the menu

#### In AF mode

3. In the **AF-Mode** sub-menu, select one of the three variants

Effect of the three function variants:

- **AF/AE lock** (factory setting)
  - Shutter release button: **AFs** setting
  - Joystick: Exposure setting, **AFs/AFc** setting
- **AE-L**
  - Shutter release button: **AFs** setting
  - Joystick: Exposure setting
- **AF-L**
  - Shutter release button: **AFs** setting
  - Joystick: **AFs/AFc** setting

#### In MF mode

In manual focus mode you can nevertheless activate AF mode temporarily, i.e. for the particular picture, and/or – depending on the setting - to save the exposure setting by pressing the Joystick forwards.

3. In the **MF-Mode** sub-menu, select one of the five variants

Effect of the five function variants

- **AFs On / AE Lock** (factory setting)  
**AFs** mode activated for one picture, saving of the exposure setting  
The resulting AF setting remains stored until it is changed by manual adjustment or by pressing the button again.
- **AFs on**  
As for **AFs On / AE Lock**, but without saving of the exposure setting
- **AFc On / AE Lock**  
As for **AFs On / AE Lock**, but with **AFc** mode
- **AFc on**  
As for **AFs On / AE Lock**, but without saving of the exposure setting
- **AE-L**  
Saving of the exposure setting

#### Displays in the viewfinder during saving of the exposure setting

- A light balance appears showing the deviation from the stored metered value.
- If aperture and/or exposure time are changed during this time, the respective other value is adapted accordingly and displayed.

## EXPOSURE COMPENSATION

Exposure compensations are possible in automatic program, shutter speed priority and aperture priority modes.

### Entering and canceling an exposure compensation in the menu

1. In the menu under **CAMERA**, select the item **Exp. Compensation**.
  - The sub-menu shows a scale with a setting mark highlighted in red. If it is at a value of **0**, this means that the function is deactivated.
2. Set the desired value by turning the rear thumbwheel or by pressing the Joystick to the left or right.
  - In the initial menu list, a set compensation is indicated by **EV+X<sup>1</sup>**

#### Note:

In the factory setting, this function can be called up directly by holding the button bottom right next to the monitor depressed.

### Displays in viewfinder and top panel display, and in Live View mode also in the monitor (in the picture data display)

- The compensation value on the light balance (viewfinder and monitor)
- A corresponding warning symbol (viewfinder)
- **+** or **-** (top panel display)

#### Notes:

- Once set, a compensation value is retained even when the camera is switched off.
- An exposure compensation set on the camera only influences metering of the available light, i.e. not flash light (for more information about flash photography, refer to the respective sections).

<sup>1</sup> Example, either plus or minus, "X" stands for the respective value



## MANUAL SETTING OF APERTURE AND EXPOSURE TIME - M

### Setting the operating mode

1. Select **M** with the rear thumbwheel (see also p. 30, "Exposure control")
2. Set the desired aperture by turning the rear thumbwheel and the desired exposure time with the shutter speed setting dial

### Displays in viewfinder and top panel display, and in Live View mode also in the monitor

- **M** for the selected exposure operating mode,
- The manually set aperture and shutter speed values, and
- A light balance with which the exposure compensation is performed. The light balance shows the deviation of the shutter speed/aperture combination just set from the metered exposure value. In the range of  $\pm 3$  EV, the deviation is shown clearly in  $\frac{1}{2}$ EV steps. Larger deviations are indicated by flashing of the outer mark of the light balance.

For correct exposure according to the exposure meter, vary the aperture and/or speed until only the zero mark of the light balance lights up.

#### Note:

If the automatic sensitivity setting (**ISO Auto**) is activated at the same time, the last manually set sensitivity is used. A minimum shutter speed that may have been set, however, is not active.

## BRACKETING

Bracketing can be employed with all four exposure operating modes.

The following are available:

- 2 numbers of pictures: 3 or 5
- Graduations: 0.5EV, 1EV, 2EV and 3EV

### Setting the function

1. In the menu under **CAMERA**, select the item **Exp. Bracketing**
  - The sub-menu appears on the monitor with the four items **Exp. Bracketing**, **Frames**, **F-Stops** and **Automatic**, and below this a scale. If an exposure compensation is set at the same time, this is indicated by a corresponding value below the scale.
2. For **Exp. Bracketing**, turn the rear thumbwheel or press the Joystick to left or right to select whether you wish to carry out bracketing (**On**) or not (**Off**)
  - If **On** is selected, the other three sub-menu items are activated (= white).
3. Press the rear thumbwheel or the Joystick forward to call up the next sub-menu item (the same applies to all sub-menu items)
4. In **Frames**, set the number of frames, and in **F-Stops** the desired exposure graduations between the pictures of the series
  - The selected exposures are displayed in red on the scale. An exposure compensation that may be set is recognizable from the fact that the whole series around the compensation value is "off-set" from the middle of the scale.
5. In **Automatic**, select whether you wish to trigger the pictures individually yourself (**Off**), or whether the pictures should all be taken in series when the shutter button is pressed once (**On**)
  - A set exposure series is indicated in the initial menu list by **X/Y EV**<sup>1</sup>.
6. All pictures are produced by pressing the shutter release button once or several times.

#### Note:

The function **Exp. Bracketing** is not available if an interval shooting series has previously been set.

### Displays in the viewfinder

- A warning symbol
- The changing displays for shutter speed and aperture corresponding to the graduations

### Displays in the top panel display

- Next to the exposure mode in front of the overexposure(s) **+**, in front of the uncorrected picture **0**, in front of the underexposure(s) **-**
- A symbol indicating an exposure series

### Displays in the monitor (in the picture data display)

- A symbol indicating an exposure series

## THE B SETTING

With the B setting, the shutter remains open as long as the shutter button is held depressed (max. 60 s).

### Display in the viewfinder

- **bulb** instead of a shutter speed

### Display in the top panel display

- **B**
- After opening of the shutter, the running exposure time

### Displays in the monitor in Live View mode

- **bulb** instead of a shutter speed

In conjunction with the self-timer, a T function is also available: If both **B** is set and the self-timer is activated by pressing the shutter release button, the shutter opens automatically after the selected delay time. It then remains open until you press the shutter release button a second time – you do not need to hold the button down. This enables you to largely prevent any blurring, even with long exposures, by pressing the shutter release button. In both cases the exposure meter remains deactivated.

<sup>1</sup> "X" stands for the number of pictures, "Y" for the graduation

**Notes:**

- Depending on the exposure mode, the exposure graduations are created by changing the shutter speeds and/or apertures.
- The sequence of the exposures is: Overexposure(s), correct exposure, underexposure(s).
- When using automatic bracketing, all **ISO Auto** settings are fixed:
  - The sensitivity automatically determined by the camera for the uncorrected picture is also used for all other pictures in a series, i.e. this ISO value is not changed during a series.
  - The settings in the **AUTO ISO** sub-menus have no influence, i.e. the full shutter speed range of the camera is available.
- Depending on the initial exposure setting, the working range for automatic bracketing may be limited.
- Regardless of this, the specified numbers of pictures are always taken, which may mean that at the end of the working range, several pictures in a series have the same exposure.
- The function remains active until it is deactivated again in the menu or the camera is switched off.

**Values above and below the metering range**

If the values are below the metering range of the camera, exact exposure metering is not possible. The metered values that may then be displayed in the viewfinder can result in incorrect exposure results.

For this reason the display **L** always appears in the viewfinder if the values are below the metering range.

**Note:**

If the values are above and below the metering range, the time or aperture value in the top panel display flashes.

**Notes:**

- The longest possible exposure time depends on the set sensitivity.
- Long exposure times can be associated with picture noise. To reduce this annoying phenomenon, the Leica S automatically takes a second “black picture” (taken with the shutter closed) after pictures with slow shutter speeds. The noise present in this parallel picture is then digitally “subtracted” from the data for the real picture.
- This doubling of the “exposure” time can be significant at longer exposure times, and must be allowed for. During this time the camera should not be turned off.
- When taking pictures with long exposures we recommend that the eyepiece cover supplied is fitted. This prevents any undesirable additional exposure.
- With shutter speeds slower than 1/8s, the message **Noise Reduction** appears in the monitor.
- Pictures taken with long exposures with the B setting are taken only with the camera's internal focal plane shutter even if the main switch is set to **B**.

**Taking photographs with the self-timer**

You can use the self-timer of the Leica S to take a picture with a delay of either 2 or 12 s.

**Setting / performing the function**

1. In the menu, under **CAMERA**, select the item **Drive Mode** and
2. select the required delay time in the sub-menu
3. To start the process, press the shutter button (see also "Shutter button")

**Note:**

During the delay time, the delay time can be restarted, i.e. prolonged, by pressing the shutter button again.

**Procedure**

With 2 s delay time:

Exposure metering is performed first, in autofocus mode the focus is adjusted and the mirror is folded up. Only then does the delay time start.

With 12 s delay time:

The delay time starts immediately after the shutter button is pressed, the mirror is folded up 2 s before the picture is taken.

**Displays**

The running delay time is displayed:

- In the monitor by the display **Capture in 12s** and the countdown of the remaining time until the picture is taken.
- By the LED on the front of the camera – for the first 10 s with 12 s delay time – first flashing slowly, then flashing fast.

### Aborting the function

A running self-timer delay time can be aborted by turning off the camera at the main switch.

A running 12 s self-timer delay time can also be aborted during the first 10 s by pressing any of the four buttons next to the monitor.

If the self-timer is no longer to be used, it must be switched off in the menu, as even switching off the camera does not cancel the setting of this function.

#### Note:

If the self-timer function is set and the mirror lock-up activated (see next section) at the same time, the shutter is always actuated after the selected delay time, i.e. without the shutter button having to be pressed again.

### Mirror lock-up

In order to preclude the minimal residual influences of mirror movement and closing of the lens shutter, the Leica S offers the possibility of the mirror lock-up.

#### Setting / performing the function

1. In the menu, under **CAMERA**, select the item **Mirror Up Mode** and
2. select **On** or **Off** in the sub-menu.
3. Press the shutter button to cause the mirror to be folded up
4. Press the shutter button again to take the picture

### Procedure

When the shutter button is pressed the first time, exposure metering is performed, in autofocus mode the focus is adjusted, then the mirror is folded up and the aperture closes to the corresponding value.

The shutter procedure - and hence the taking of the picture - starts only when the shutter button is pressed a second time.

After the picture is taken, the mirror is folded down again and the aperture opens in the normal way.

### Aborting the function

The mirror lock-up procedure can be aborted without a picture being taken after the shutter button is pressed the first time.

Simply switch off the camera at the main switch and the mirror is folded down again.

If the mirror lock-up is set, on the other hand, the function remains active even after turning the camera off and on again, i.e. if the next picture is to be taken without mirror lock-up, the function must be set to **Off** in the menu.

#### Notes:

- The picture must be taken within 2 minutes of the shutter button being pressed the first time. If this is not the case, the mirror is folded down again automatically to protect the battery capacity (without the shutter opening beforehand).
- While the mirror is folded up, the 2 minutes holding time can be restarted at any time by pressing the shutter button again.
- If the mirror lock-up is activated and the self-timer function set at the same time, the shutter is always actuated after the selected delay time, i.e. without the shutter button having to be pressed again.

### Depth of field preview button

With the Leica S you can close the lens aperture to the set or automatically controlled aperture value in any exposure mode. In the factory setting, this is done with the depth of field preview button.

The correct values continue to be displayed in the monitor and top panel display, and in Live View mode also in the monitor. However, exposure metering is deactivated.

Preconditions for closure of the lens aperture are

- Exposure metering has been activated with the shutter button, and
- The shutter button has not been pressed (again).

The shutter is blocked as long as the button is held depressed.

#### Note:

The function of the depth of field preview button differs, depending on the operating mode:

Operating mode		Function
Photo mode	Normal, i.e. use of the viewfinder image	Close the aperture by holding the button depressed or quick access to the set menu function by pressing
	Live View, i.e. use of the viewfinder image	Activating/deactivating exposure simulation by (multiple) pressing
Video preview and recording mode		Access to setting the audio recording level and the headphone volume by holding depressed, function independent of the setting for normal photography mode and cannot be changed

## ADDITIONAL FUNCTIONS

### USER / APPLICATION-SPECIFIC PROFILES

On the Leica S, any combination of menu settings can be permanently stored, e.g. so that they can be retrieved quickly and easily at any time for recurring situations / subjects. A total of four memory slots are available for these combinations, as well as a factory default setting that can be retrieved at any time and cannot be changed. You can change the names of the saved profiles. Profiles set on the camera can be transferred to one of the memory cards, for example for use in other camera units, while profiles stored on a card can be transferred onto the camera.

#### Saving settings / Creating a profile

- Set the desired functions in the menu
- In the menu, under **SETUP**, select the item **User Profiles** and
- select **Save as User Profile** in the sub-menu
  - A further sub-menu appears with four lines for the available profile slots.
- In this sub-menu, select the desired memory slot
  - A corresponding confirmation prompt appears
- Confirm **Yes** or cancel **No** your selection there
  - The sub-menu from step 4. appears again, and the selected memory slot is marked as occupied.

#### Selecting a profile

- In the menu, under **SETUP**, select the item **User Profiles** and
  - select **Load Profile** in the sub-menu
    - A further sub-menu appears with five lines, the first for the factory settings, the others for the four profile slots.
- Only the lines with occupied profiles can be called up.
- In this sub-menu, select the desired profile
    - The selected profile is marked as **active**.

#### Note:

If you change one of the settings for the profile currently in use — appears instead of the name of the profile you were previously using in the initial menu list.

### Renaming profiles

- In the menu, under **SETUP**, select the item User Profiles, and
- select **Rename User Profile** in the sub-menu
  - A further sub-menu appears with four lines for the profile slots.

Only the lines with occupied profiles can be called up.

- Select the desired profile
  - A keyboard sub-menu is displayed.
- First delete the existing designation in the title line there, then select the desired characters
  - Turning the rear thumbwheel or pressing the Joystick to left or right allows each character to be selected in an endless loop.
  - Pressing the Joystick up or down allows you to move between lines.
  - Pressing the rear thumbwheel or the Joystick forward copies the selected character to the title line.
  - Special "buttons":

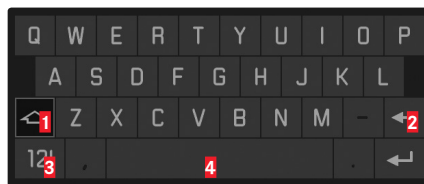

- 1** Switch between capital and small letters
  - 2** Delete characters
  - 3** Switch between letter and number, or punctuation marks and special characters
  - 4** Spacebar
- Confirm your inputs with the function keys marked **OK** or **OK** to the top right or bottom right of the monitor
    - The sub-menu from step 2. appears again, the edited profile has the new designation.

### Saving profiles to a card / transferring profiles from a card

- In the menu, under **SETUP**, select the item **User Profile** and
- select **Import from card** or **Export to Card** in the sub-menu.
  - A corresponding confirmation prompt appears
- Confirm there that you really wish to import or export the profile.

#### Note:

When exporting, all profile slots are transferred to the card, i.e. including any empty profiles.

As a result, when importing profiles any existing profiles in the camera will be overwritten, i.e. deleted.

### RESETTING ALL CUSTOM SETTINGS

This function allows you to delete all previous custom settings in the menu at once, and to reset them to the factory default settings.

#### Setting the function

- In the menu, under **SETUP**, select the item **Reset Camera** and
- select **No** or **Yes** in the sub-menu.

#### Note:

This reset also applies to the profiles that may have been created and saved with **Save as User Profile** (see left column).

## FOLDER MANAGEMENT

The picture data on the memory cards is stored in folders which are created automatically. The folder names always consist of eight characters - three figures and five letters. In the factory default setting, the first folder is named "100LEICA", the second "101LEICA", etc. The next free number is always assigned as the folder number; a maximum of 999 folders are possible. If the number capacity is exhausted, a corresponding warning message appears in the monitor.

The individual pictures are given continuous numbers up to 9999 unless a memory card in use already contains a picture with a higher number than the last number assigned by the camera. In such cases, the numbering used on this card is continued. If the current folder contains picture number 9999, a new folder is created automatically and the numbering begins again at 0001. If folder number 999 and picture number 9999 are reached, a corresponding warning message appears in the monitor and the numbering must be reset (see below).

With the Leica S you can also create new folders at any time, give them names of your choice and change the file names.

### Create new folder / Assign names of your choice

- In the menu, under **SETUP**, select the item **Image Numbering** and
- select **New Folder** in the sub-menu
  - A keyboard sub-menu appears with the folder names in the title line (initially always "XXXLEICA").
- First delete the existing designation in the title line there, then select the desired characters
  - The procedure corresponds exactly to step 4. under 'Renaming profiles' on p. 36.

- Confirm your inputs with the function keys marked **OK** to the top right or bottom right of the monitor
  - A corresponding confirmation prompt appears.
- Confirm **Yes** or cancel **No** your settings there
  - The keyboard sub-menu appears again.

#### Note:

If memory cards are used that were not formatted with this camera (see next section), the camera automatically creates a new folder.

### Resetting picture numbers

The picture numbers can also be reset without having to create a new folder first.

- In the menu, under **SETUP**, select the item **Image Numbering** and
- select **Reset** in the sub-menu

The keyboard sub-menu appears.

- Make the desired settings there

The procedure corresponds exactly to that described in the previous section under 3. - 5.

### Changing file names

- In the menu, under **SETUP**, select the item **Image Numbering** and
  - select **Change Filename** in the sub-menu.
    - A keyboard sub-menu appears with the file names (initially always L100 001).
  - Make the desired settings there
- The procedure corresponds exactly to that described in step 4. under 'Renaming profiles' on p. 36.
- The sub-menu from step 2. appears again, the edited file name has the new designation.

## FORMATTING THE MEMORY CARDS

It is not normally necessary to format (initialize) memory cards that have already been used. If an unformatted card or a card formatted in a different device (e.g. a computer) is used for the first time, it has to be formatted.

#### Important:

Formatting does not necessarily and irrevocably delete all the data on the card.

It may be possible to access some of the data again using appropriate software. Only the data that is then overwritten by saving new data is actually permanently deleted.

#### Notes:

- Do not turn the camera off while memory cards are being formatted.
- If the memory card has been formatted in another device, such as a computer, you should reformat it in the Leica S.
- If a memory card cannot be formatted, you should ask your dealer or the Leica Product Support department for advice.
- Formatting of memory cards deletes even delete-protected pictures (see p. 50).

### Setting the function

- In the menu, under **SETUP**, select the item **Format Cards** and
- select in the sub-menu which of the two cards you wish to format, or whether you wish to format both
  - A corresponding confirmation prompt appears on the monitor to prevent inadvertent deletion.
- Confirm **Yes** or cancel **No** your selection there

<sup>1</sup> The "X" characters are placeholders

## MARKING THE PICTURE FILES FOR COPYRIGHT PROTECTION

The Leica S enables you to mark your picture files by entering text or other characters. You can enter up to 17 characters under 2 headings for each picture.

- In the menu, under **SETUP**, select the item **Copyright Information**
  - The sub-menu containing the three options **Copyright**, **Information** and **Artist** appears in the monitor. Only the **Copyright Information** line is initially activated.
- Activate the **Copyright** function.
  - The **Information** and **Artist** lines are activated.
- Select **Information** or **Artist**, and
  - The keyboard sub-menu appears in both cases.
- Make the desired settings there
 



The procedure corresponds exactly to that described in section "Resetting picture numbers" in steps 3./5.

  - The sub-menu from step 2. appears again.

## RECORDING THE LOCATION WITH GPS

The Global Positioning System enables the current position of the receiver to be determined worldwide. When the function is activated the Leica S continuously receives the corresponding signals and updates the position data. You can write this information - latitude and longitude, height above sea level - to the "EXIF" data.

### Setting the function

- In the menu, under **SETUP**, select the item **GPS** and
- switch the function **On** or **Off**
  - The "Satellite" symbol in the top panel display indicates the status:
    -  Last position determined up to 6 minutes ago
    -  Last position determined up to 24 hours ago
    -  No position data available

### Notes on the function:

- GPS positioning requires as clear a path as possible to at least 3 of the GPS satellites (of the total of 24 satellites, up to 9 are available from any point on earth). We therefore recommend holding the camera with the GPS aerial pointing vertically upwards.
- Make sure that the GPS aerial is not covered with your hand or any other item, particularly metal objects.
- It may not be possible to receive good signals from GPS satellites at the following locations or in the following situations. In such cases, positioning may not be possible at all, or may be incorrect:
  - In closed rooms
  - Underground
  - Under trees
  - In a moving vehicle
  - Close to high buildings or in steep valleys
  - Close to high voltage cables
  - In tunnels
  - Close to mobile telephones
  - With accessories attached to the flash shoe, e.g. a flash unit

We recommend that when activating the GPS function after prolonged storage of the camera, this is always done first at a point with good "reception".

### Information for safe use

The electromagnetic radiation generated by the GPS system can affect instruments and measuring equipment. Therefore, make sure the GPS function is deactivated e.g. on board an aircraft before takeoff or landing, in hospitals or in other locations where there are restrictions on wireless transmissions.

### Important (legal restrictions on use):

- In certain countries or regions, the use of GPS and associated technologies may be restricted.
- Therefore, before traveling in other countries you should consult the relevant country's embassy or your travel agent.
- The use of GPS inside the People's Republic of China and Cuba and close to their borders (exceptions: Hong Kong and Macao) is prohibited by national laws.
- Violations will be prosecuted by the authorities. The GPS function is therefore deactivated automatically in these areas.

## FLASH MODE

### GENERAL INFORMATION ON FLASH EXPOSURE MEASUREMENT AND CONTROL

The Leica S determines the necessary flash power by firing several ranging flashes in quick succession fractions of a second before taking the actual picture. Immediately after this, at the start of exposure, the main flash is fired.

All factors that influence the exposure (e.g. filters, aperture setting, distance from the main subject, reflective ceilings, etc.) are automatically taken into consideration.

### COMPATIBLE FLASH UNITS

Connection via the flash shoe

- All flash units and studio flash systems conforming to the latest ISO standard 10330 and the older DIN 19014 standard<sup>1</sup> (positive polarity at the X contact)

Connection via the lower LEMO® jack

- All flash units and studio flash systems that allow control via corresponding special cables

Connection via the flash connection socket

- Studio flash systems and other flash units with flash cable and standard flash plug

The following flash units allow all the functions described in this manual together with the Leica S:

- Leica system flash units
- Flash units that satisfy the technical requirements for a System 3002 System Camera Adaption (SCA), are fitted with the SCA-3502-M5<sup>2,3</sup> adapter and allow guide number control.







Other commercially available attachable flash units with standard flash foot<sup>4,5</sup> and positive center contact, and fired via the center contact (X contact) (without TTL flash control) can also be used.

## FLASH SYNC SPEED

The flash sync speed of the Leica S with conventional flash technology, i.e. with the camera's internal focal plane shutter is  $\frac{1}{25}$ s. If the central shutter of correspondingly equipped lenses is used, all the shutter speeds up to  $\frac{1}{1000}$ s are available.

With system-compatible and HSS-compatible flash units, all faster shutter speeds can also be used.

### Notes:

- Studio flash systems in particular often have burning times that are far longer than the above sync times. Lower speeds are recommended to make full use of light yield from these flash units.
- With all shutter speeds up to the sync time  $\frac{1}{25}$  s,  lights up in the viewfinder as an indication that normal flash mode is possible with these speeds.
- If the shutter speed setting dial is set , the set exposure operating modes may be changed due to the then resulting shutter speeds, i.e. from  to , or from  to . As soon as a shutter speed is set again, the original operating modes are activated again.
- If an HSS-compatible Leica system flash unit is used and faster shutter speeds are set at the camera, i.e.  $\leq \frac{1}{80}$ s with focal plane shutter, and  $\leq \frac{1}{500}$ s with central shutter, the flash unit automatically switches to HSS mode.

<sup>2</sup> When using the SCA-3502 adapter (from Version 5), the white balance can be set to **Automatic** for correct color reproduction.

<sup>3</sup> The use of system flash units from other camera manufacturers and of SCA adapters for other camera systems is not recommended, as their different contact position and assignment can result in malfunctions or even damage.

<sup>4</sup> If flash units not specially adapted to the Leica S are used, the white balance of the camera should possibly be set manually to .

<sup>5</sup> The aperture and sensitivity of the lens may have to be entered manually in the flash unit.

<sup>1</sup> If you wish to connect a studio flash system that does not conform to the ISO standard to the Leica S, please contact the Customer Care department at Leica Camera AG or the customer service department of a Leica agency.

### SELECTING THE SYNC SPEED / THE SYNC SPEED RANGE

The Leica S allows you to combine flash operation with the shutter speed generated with the automatic program and aperture priority modes to subtly change the lighting conditions for the relevant subject to suit your compositional ideas. You can choose here between one automatic and several manual settings.

#### Setting the function

1. In the menu under **CAMERA**, select item **Max. Flash Sync. Time**, and
2. in the sub-menu select either one of the three automatic, focal length-specific settings - **1/f**, **1/2f**, **1/4f**, or the desired slowest shutter speed

#### Note:

The setting of **1/f** results in the slowest shutter speeds according to the rule of thumb for blur-free pictures taken from the hand, e.g.  $\frac{1}{60}$ s with the Summarit-S 1:2.5/70mm ASPH lens. The corresponding shutter speeds with **1/2f** and **1/4f** in this example would be  $\frac{1}{125}$ s and  $\frac{1}{250}$ s.

### SELECTING THE FIRING MOMENT

The Leica S allows you to choose between the flash firing moment at the start of the exposure and the synchronisation at the end of the exposure. The function is available with all flash units, i.e. even with non-system-compatible flash units, irrespective of whether they are fitted to the flash or connected via cable, and with all camera and flash unit settings. The displays are identical in both cases.

#### Setting the function

1. In the menu under **SETUP**, select item **Flash Sync. Mode**, and
2. select the desired option in the sub-menu

### ATTACHING THE FLASH UNIT

When attaching a flash unit, you should ensure that the foot of the flash unit is fully inserted into the accessory shoe of the Leica S and, if fitted, the clamping nut is tightened to prevent it accidentally falling out. This is particularly important for flash units with additional control and signal contacts, because if the position in the flash shoe changes the necessary contacts can be broken, leading to malfunctions.

#### Note:

Camera and flash unit must be switched off before attaching.



### SETTINGS FOR CAMERA-CONTROLLED AUTOMATIC FLASH MODE

When the flash unit used has been switched on and set to the appropriate mode for TTL mode, exposure metering must be carried out on the Leica S

1. before taking each flash picture by gently pressing the shutter release, so that the display in the viewfinder shows the shutter speed or switches to the light balance. If this stage is missed out by fully depressing the shutter release in one quick movement, the flash unit will not fire even if required.
2. the desired exposure mode and the desired shutter speed and/or aperture must be set. The shortest flash sync speed must be taken into account as this determines whether a "normal" flash is fired or an HSS flash.

### TTL flash mode

The fully automatic, i.e. camera-controlled, TTL flash mode is available with the Leica S with system-compatible flash units, and with all exposure operating modes of the camera. In addition, an automatic fill flash control is available. This means that in order to ensure a balanced relationship between flash and other lighting at all times, the flash power is reduced by up to 1½ EV as ambient brightness increases (fill flashes). If, however, the prevailing brightness requires a faster shutter speed than the sync speed ( $1/25\text{s}$  with focal plane shutter,  $1/1000\text{s}$  for lenses with central shutter) or if this is set manually, a system-compatible flash unit will be automatically switched to linear flash mode (HSS, see next section) by the camera. In addition, the Leica S transfers the set sensitivity and aperture to the flash unit. If it has such displays, the flash unit can then automatically adapt its distance setting accordingly.

#### Notes:

- The following sections describe only those settings and functions that are available when using the Leica S with system-compatible flash units.
- An exposure compensation set at the camera influences only the measurement of the prevailing light! If you want to simultaneously use compensation of the TTL flash exposure metering in flash mode – in parallel or in the opposite direction, you must make this additional setting (on the flash unit).
- More details of flash use, in particular for other flash units not specially adapted to the Leica S and for different flash modes, can be found in the relevant manuals.

### LINEAR FLASH MODE (HIGH SPEED SYNCHRONIZATION)

Fully automatic, i.e. camera controlled, linear flash operation is available with the Leica S when using system-compatible flash units (see p. 39), with all shutter speeds and in all exposure modes of the camera. It is automatically activated by the camera when the selected or calculated shutter speed is faster than the sync speed, i.e.  $\leq 1/80\text{s}$  with focal plane shutter. If the flash unit is set correctly, this changeover requires no further action on the part of the photographer.

### STROBOSCOPE FLASH MODE WITH SYSTEM-COMPATIBLE FLASH UNITS

This flash method in which several consecutive flashes are fired during an exposure is possible with all exposure operating modes of the camera. With the operating modes and the camera automatically sets the shutter speed necessary for the selected number and frequency of flashes. If the required shutter speed results in an overexposure due to the prevailing light, this is indicated by the light balance. With the operating modes and flashing of the time display in the viewfinder and top panel display signals that the shutter speed is too high. In such cases exposure compensation is possible by changing the number and/or frequency of the flashes and/or the aperture and/or the shutter speed (with and ). For successful stroboscope photography in which e.g. several phases of a sequence of movements are recorded in one picture, the working range of the flash unit, the number of flashes, the distance and naturally the aperture are of crucial importance. Information on this can be found in the manual of the flash unit in question.

#### Note:



The HSS flash technology results in shorter ranges.

## FLASH EXPOSURE DISPLAYS IN THE VIEWFINDER WITH SYSTEM-COMPATIBLE FLASH UNITS





In the viewfinder display of the Leica S, a flash symbol serves as a feedback and display of various operating states.

-  does not appear despite the flash unit being switched on and ready for use:

In such cases the Leica S will not fire the flash unit even though it is switched on and ready for use. (e.g. because the wrong operating mode is set on the flash unit)

-  flashes before the picture is taken:
  - The flash unit is not yet ready to use
-  is lit up before the picture is taken:
  - The flash unit is ready for use
-  continues to light up constantly after firing:
  - The flash is still ready to use.
- In the case of a flash exposure compensation set at the flash unit
  - $\pm$  appears additionally in the viewfinder as an indicator

## FLASH PHOTOGRAPHY WITH THE FLASH UNIT-INTEGRATED AUTOMATIC COMPUTER





When working with the automatic exposure of system-compatible flash units, the light reflected by the subject is metered and evaluated by a sensor integrated into the flash unit, not by the camera. The exposure operating modes of the camera function essentially in the same way as without flash. If the flash sync speed drops below the set value with  or , or a speed is set below the sync speed with  or , the flash is not triggered.

As the operating modes, and already generate a normally exposed picture due to the ambient lighting, the flash power should be reduced, i.e. a flash exposure compensation of e.g.  $-1\text{EV}$  to  $-2\text{EV}$  should be set.

With system-compatible flash units, the aperture set at the lens is transmitted to the flash unit and automatically taken as the basis as computer aperture. For the metering, the sensitivity set at the camera and any exposure compensation set for the ambient lighting (camera) and flash (flash unit) are taken into consideration.

## MANUAL FLASH PHOTOGRAPHY WITH CONSTANT FLASH POWER

If the flash unit is used in manual flash mode with full power or fixed partial power (if this can be set at the flash unit), the emitted flash light power is not controlled. The exposure operating modes of the camera function essentially in the same way as without flash.

If the flash sync speed drops below the set value with  or , or a speed is set below the sync speed with  or , the flash is suppressed. The lens aperture to be set is determined by the flash power, sensitivity and distance to the subject, or vice versa, the flash partial power to be set is determined by the aperture, sensitivity, focal length and distance to the subject (see flash unit manual).

## FLASH PHOTOGRAPHY VIA THE X CONTACT

No information is transmitted if a non-system-compatible flash unit is connected via the accessory shoe. As the camera cannot "recognize" such a flash unit, it acts as if no flash unit were attached. The flash time must be set manually to the flash sync speed  $\frac{1}{25\text{S}}$ , or  $\frac{1}{1000\text{S}}$  with central shutter, or to slower speeds; an automatic changeover does not take place. The flash unit ready and indicator lamps are not active.

If the flash unit is suitable, the light control can be performed with an automatic aperture, i.e. via the sensor on the flash unit, or manually by selecting corresponding partial light power levels (see flash unit manual).

## FLASH PHOTOGRAPHY VIA THE LOWER LEMO® JACK

Flash units and large studio flash systems can be connected by cable with LEMO® plug (supplied) can be connected to the lower LEMO® jack. The LEMO® jack with its automatic locking reliably prevents an inadvertent interruption in the connection. As the camera cannot "recognize" a flash unit connected in this way, it acts as if no flash unit were attached. The flash time must be set manually to the flash sync speed  $\frac{1}{25\text{S}}$ , or  $\frac{1}{1000\text{S}}$  with central shutter, or to slower speeds; an automatic changeover does not take place. The flash unit ready and indicator lamps are not active.

## VIDEO RECORDINGS

You can also use the Leica S to make video recordings.

### Notes:

- As only part of the sensor surface is used, the effective focal length is increased in each case, i.e. the details become correspondingly smaller.
- Uninterrupted video recordings are possible up to a maximum length of 29 minutes.

The following settings are available for video recordings:

### RESOLUTION / IMAGE FREQUENCY

1. In the menu, under **IMAGE**, select the item **Video Resolution** and
2. set the desired resolution in the sub-menu

The two resolutions available have a fixed relationship to different image frequencies. 1080p, for example, can be combined with three different image frequencies in order to match the reproduction to the TV system used: 25 fps for PAL, 24 and 30 fps for NTSC while the 4K resolution is only possible with 24 fps.

### Note:

4k video recordings can only be stored on SD cards (see p. 25).

### ISO SENSITIVITY

All variants described on p. 24, but **Maximum Auto ISO** for video recordings is set separately in the **Auto ISO Video** sub-menu.

### Notes:

- The limitation described below under exposure operating modes applies.
- Vertical and horizontal lines may become visible all over the image, especially when shooting dark subjects with high ISO values containing very bright, spot light sources.

## COLOR SPACE

Video recordings are only possible with sRGB (see p. 22).

### Note:

This applies irrespective of a possible deviating setting for photos which remains unchanged.

### CONTRAST, FOCUS, SATURATION

All variants described on page 22, but they are set separately for video recordings.

1. In the menu, under **IMAGE**, select the item **Video Settings** and
2. select **Video Contrast**, **Video Sharpness** or **Video Saturation** in the sub-menu, and
3. select the desired level/function in the sub-menu

## TIME CODE

The time code is a data set that is generated and recorded parallel to the image and audio data. It allows the correct time synchronization of picture and audio signals even after cutting, or after a later separate processing.

You can choose between a continuous 'running'

**Timecode** – **Free Run** and a time code for the particular recording – **Rec Run**

1. In the menu, under **IMAGE**, select the item **Video Settings** and
2. select **Timecode** in the sub-menu
3. In the **Timecode** sub-menu select **Timecode Mode** and
4. select the desired function or deactivate the function in the sub-menu

While the time code signal at camera time is always generated and recorded parallel to the video recording, with **Free Run** and **Rec Run** you can define the start yourself, i.e. how large the time offset is to be between the start of recording and the start of time code signal generation. In these two cases, the otherwise inactive second line of the **Timecode** sub-menu can therefore be selected.

5. In the **Timecode Mode** sub-menu select Starting Time and
6. set the delay in the sub-menu
  - Setting the numerical groups (**hh** [hours], **mm** [minutes], **ss** [seconds] and **frame** [frame number within the respective second]): Turn the rear thumbwheel or press the Joystick up or down
  - Switching between the numerical groups: Press the rear thumbwheel or the Joystick forwards, to the left or to the right

## EXPOSURE METERING METHODS

All the variants described on page 30

## EXPOSURE MODES

- Aperture priority (see p. 30-31)
- Manual control with shutter speeds of  $\frac{1}{30}$  -  $\frac{1}{4000}$ s.  
Set slower shutter speeds are dealt with in the same way as  $\frac{1}{30}$ s.

### Notes:

- If a correct exposure is not possible even with the maximum aperture, the ISO sensitivity is automatically increased, regardless of any manual setting.
- The automatic exposure control takes all brightness fluctuations into consideration. If this is not desired, e.g. for landscape recordings and pans, you should set the exposure manually.

## DISTANCE SETTING

All the variants described on page 29

## STARTING / ENDING THE RECORDING

### Starting:

Press the video record button

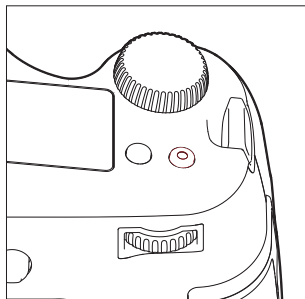

- A video recording in progress is indicated in the monitor by a flashing red dot and the elapsed recording time.
- As video recordings with the Leica S are made with different aspect ratios, depending on the selected resolution, the monitor image appears with corresponding masking.

### Ending:

Press the video record button again

## Single pictures during video recordings

Single pictures can be taken during a running video recording. Pressing the shutter button interrupts the video recording for the duration of the single picture. The individual pictures are taken with the relevant settings on the camera.

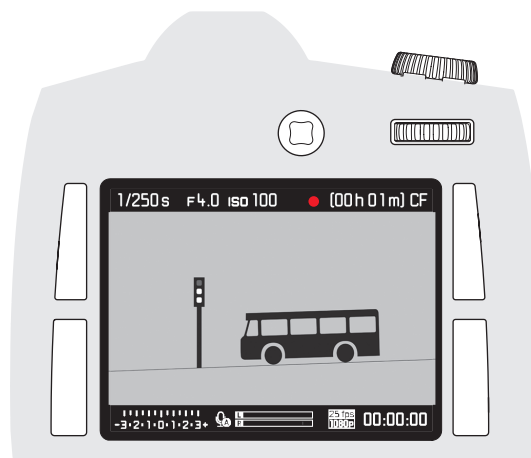

## Sound recording

The sound can be recorded using the integral microphones or with external microphones connected using the LEMO® audio adapter supplied. The integral microphones record in stereo.

### Note:

The automatic distance setting (autofocus) generates noises that are also recorded.

Setting the audio recording level is possible automatically or manually before or during the recording.

1. In the menu, under **IMAGE**, select the item **Video Settings**,
2. select **Audio Level** in the sub-menu, and
3. set the desired function there

## Manual setting

1. Hold the depth of field preview/function button depressed, and
2. press the Joystick to the left (= decrease level) or right (= increase level)

The level should be set so that input override is avoided, i.e. such that the 'bars' do not or only seldom change from white to red (at the far right end of the scale).

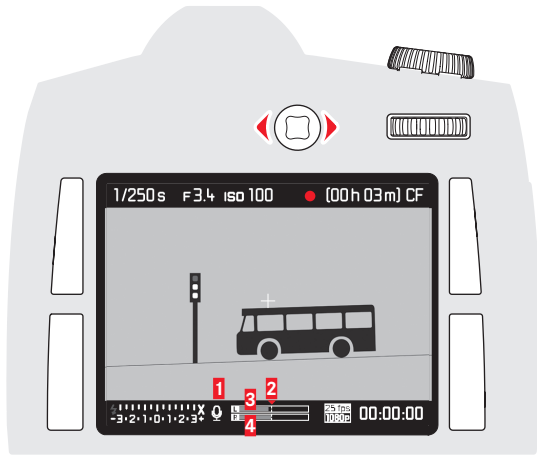

1 Microphone (🔊 = Automatic recording level control, 🎧 = Manual recording level control, 🚫 = No sound recording)

2 Setting mark

3 Left channel level

4 Right channel level

### Note:

The level is not controlled separately for each channel.

## Deactivate sound recording

Move the setting mark completely to the left until the microphone symbol changes from 🎧 to 🚫

To reduce any noise caused by wind during sound recording, a damping function is available.

1. In the menu, under **IMAGE**, select the item **Video Settings**,
2. select **Audio Wind Elimination** in the sub-menu, and
3. activate or deactivate the function there

### Note:

When no wind noise is to be feared, you should always select **Off** to ensure optimum sound.

## Checking the sound recording

You can check your recording level even during the recording using connected headphones.

1. Connect the headphones to the camera via the LEMO® audio jack using the audio adapter S (supplied)
  - The corresponding display appears in the monitor image

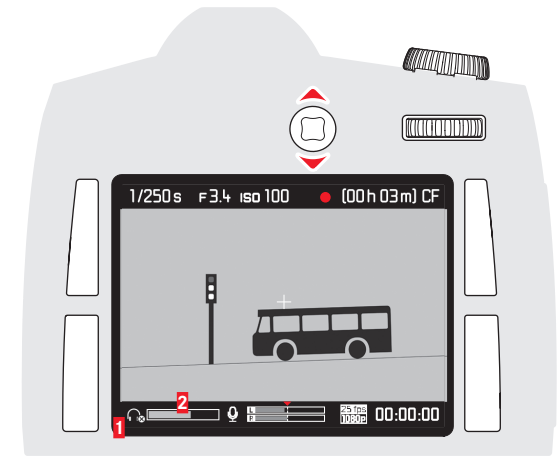

1 Symbol for connected headphones

2 Volume bar

## Setting headphone volume

2. Hold the depth of field preview/function button depressed, and
3. press the Joystick down (= reduce volume) or up (= increase volume)

## REVIEW MODE

### Note:

Two functions are available for the review of your recordings:

- Automatic review after each recording
- Review for unlimited time

## AUTOMATIC REVIEW OF LAST

### PICTURE

In **Auto Review** mode, each picture is displayed on the monitor immediately after it is taken. You can set the time for which the picture is to be displayed.

### Setting the function

1. In the menu, under **SETUP**, select the item **Auto Review** and
2. select the desired function or time in the sub-menu: (**Off**, **1 s**, **3 s**, **5 s**, **Hold**)

## REVIEW FOR UNLIMITED TIME

### Setting the function

Call up Review mode by briefly pressing the button to the top right of the monitor.

- The last picture taken appears in the monitor along with the corresponding displays. However, if the memory card(s) inserted do(es) not contain any image files, the following message appears when you switch to review mode: **No media file to display.**

Displays in Review mode

For undisturbed viewing of the recordings, only the following are displayed during review for unlimited time:

- In the header some fundamental information
  - The functions of the adjacent buttons for 3 seconds in the four corners of the monitor picture when switched on: **⏏** = Protect menu, **i** = Change of display, **⏏** = Delete menu and **☰** = Menu
  - Top right **⏏** and **⏏** for the functions of the two thumbwheels
  - Bottom right **⏏** for button lock (if activated)
- If the memory card or the selected file cannot be read, a corresponding symbol appears in the right-hand margin of the black picture.

### Notes:

- From **Auto Review** mode, you can switch back at any time to normal unlimited PLAY review mode.
- Even pictures that have not yet been transferred from the camera's internal buffer memory to a card – the LED at bottom right on the rear of the camera is still flashing – can be viewed immediately.
- On the other hand, the pictures on the cards are not accessible while data are being transferred.
- If the masking function was used during recording (see p. 28), the photo appears with the selected aspect ratio.
- Only picture data recorded with Leica S cameras can be reviewed with the Leica S.
- If the picture data are stored in parallel in JPEG and DNG format, the picture displayed is always based on the DNG file.
- If photographs were taken with the picture series function or automatic bracketing, the last picture in the series is shown first in both review modes.
- To select other pictures from the series, see p. 48.

## VIDEO PLAYBACK

A video recording can be recognized from the following characteristics:

- Picture format (16:9 with Full HD, approx. 17:9 with 4K)
- Additional video-related information in a footer
- A field with the video and audio control symbols when switching on and each time the Joystick is pressed to the left:

Louder	= Press up
Fast forward	= Press right
Play/Pause	= Press forward
Quieter	= Press down
Fast rewind	= Press left

Fast forward and fast rewind start in slow motion and get faster the longer the button is held down in the appropriate direction.

Turning the rear thumbwheel once to the left or right takes you directly to the beginning or end of a video.

## Setting the volume

Press the Joystick down (= reduce volume) or up (= increase volume)

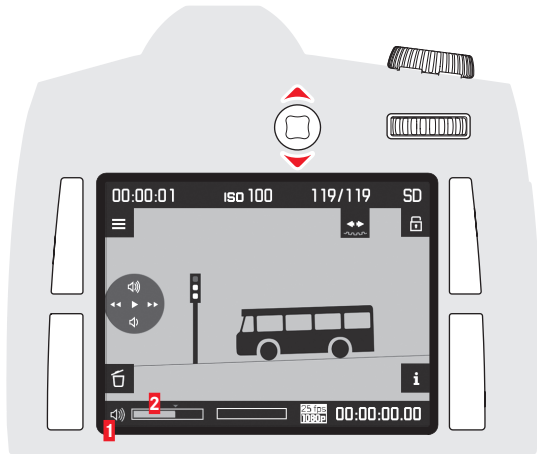

**1** Symbol for camera loudspeaker / connected headphones

**2** Volume bar; at the far left-hand end of the bar the audio playback is deactivated (🔇 / 🗣️).

## Displays in Review mode

For undisturbed viewing of the recordings, only the following are displayed during review for unlimited time:

- In the header some fundamental information
  - The functions of the adjacent buttons for 3 seconds in the four corners of the monitor picture when switched on: = Protect menu, = Change of display, = Delete menu and = Menu
  - Top right and for the functions of the two thumbwheels
- If the memory card or the selected file cannot be read, a corresponding symbol appears in the right-hand margin of the black picture.

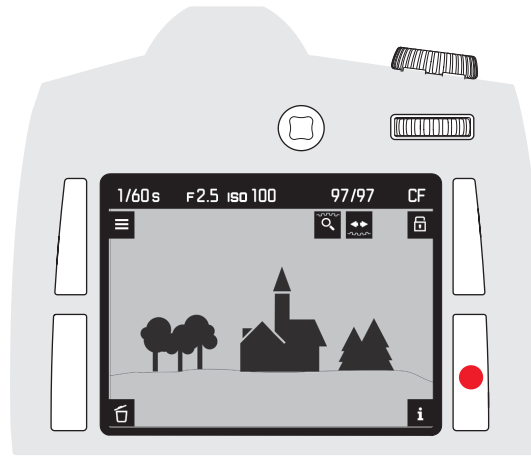

During both the unlimited review and the video payback, various additional displays and information can be called up in turn, in addition to the displays described above, by repeatedly pressing the button bottom right next to the monitor as in Live View mode:

- Histogram and clipping indicators
- Grid lines and horizon
- Extended picture data
- Back to the normal view

The settings for grid lines, histogram and marking of clearly focused subjects are made in exactly the same way as described for Live View mode on pages 27-28.

## Review with histogram and clipping indicators

- Also displayed are:
  - The histogram at top left
  - Areas that are too bright are marked in red, areas that are too dark in blue, flashing in each case, and at bottom right the clipping symbol ()

## The clipping displays

You can use the menu to set the clipping thresholds for displaying both the light and dark areas.

### Setting the function

1. In the menu, under **SETUP**, select the item **Capture Assistants** and
2. select **Exposure Clipping** in the sub-menu.
3. In the sub-menu select **Lower Limit** or **Upper Limit**, and
4. set the desired threshold values on the scale by turning the thumb-wheel or by pressing the Joystick to the left or right.
  - The scale shows the clipping areas relative to the overall exposure range.

### Notes:

- The histogram and the clipping indicators are available both during review of the whole picture and during review of a detail, but not
- during the simultaneous review of 4 or 9 reduced pictures.
- The histogram and clipping indicators always relate to the detail of the part of the picture currently being displayed.

## Marking of clearly focused subjects

- All clearly focused subjects are marked by highlighted contours.

The four available colors permit adaptation to any background.

1. In the menu, under **SETUP**, select the item **Capture Assistants** and
2. select **Focus Peaking** in the sub-menu
3. Call up the sub-menu, and
4. select the desired color there

## Extended picture data

- A wide variety of additional picture data is displayed.

### Note:

This review option only allows you to view the entire picture, even if only a section was previously selected

## VIEWING OTHER PICTURES / SCROLLING

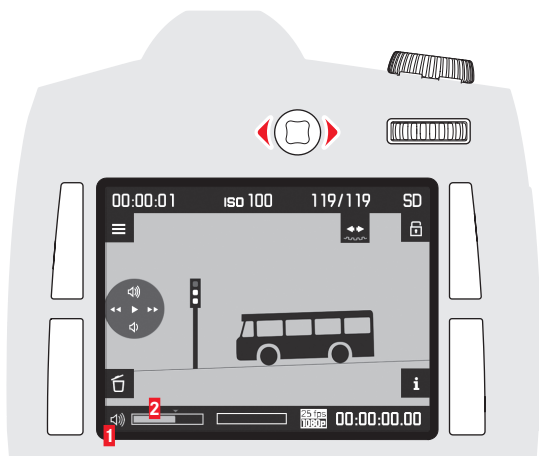

Turning the rear thumbwheel allows you to select other pictures. Turning to the left takes you to the pictures with lower numbers, turning to the right to the pictures with higher numbers. After reaching the highest and lowest numbers, the series of the pictures arranged in an endless loop starts again from the beginning so that you can reach all the pictures in both directions.

- The picture and file numbers in the monitor change accordingly.

**Note:**

This is possible in all review modes, at all zoom levels, including off-center details, and during the simultaneous review of several reduced pictures.

## ENLARGING THE DETAIL

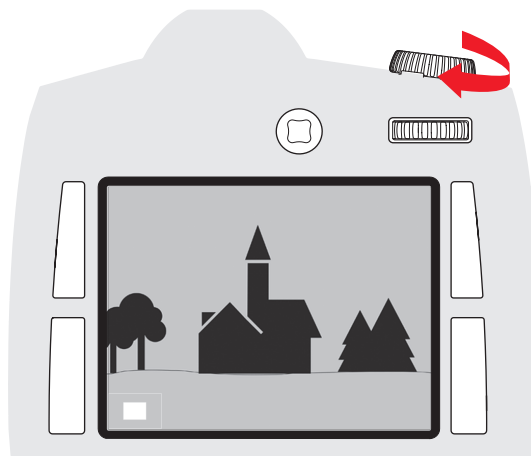

You can enlarge a detail of the picture

- in steps
- or
- call up the highest possible enlargement in one step.

**Enlarging in steps**

The displayed detail can be enlarged by turning the shutter speed setting dial to the right. The further you turn, the greater the enlargement and the smaller the detail. Enlargement is possible in 4 steps until 1 pixel of the monitor displays 1 pixel of the picture.

- The displays in the header and the symbols for the functions of the keys and thumbwheels disappear. The rectangle inside the frame shows the size and position of the detail.

**Maximum enlargement in one step**

Holding the rear thumbwheel depressed ( $\geq 1$  s) switches between the review of the whole picture and maximum enlargement.

**Note:**

The function is available at all zoom levels. If a detail was previously displayed, pressing the first time displays the whole picture again.



## MOVING THE DETAIL

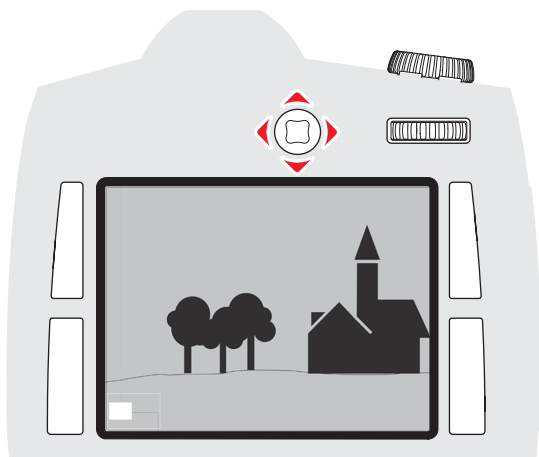

Press the Joystick in the desired direction - up, down, right or left

- The rectangle inside the frame moves in the direction the Joystick is pressed.

## SIMULTANEOUS VIEWING OF SEVERAL REDUCED PICTURES

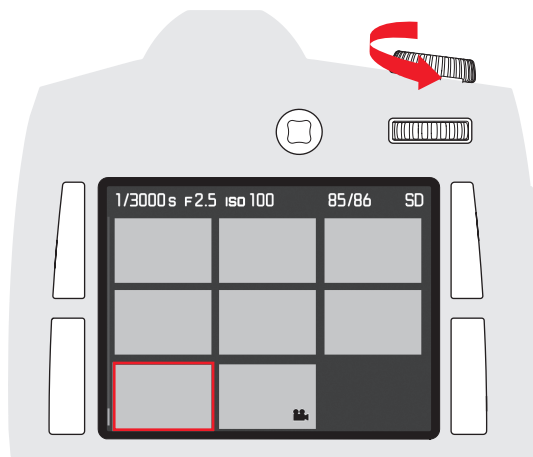

Turning the shutter speed setting dial to the left reduces possibly previously enlarged pictures, and turning beyond the review of the whole picture allows simultaneous viewing of 4 or 9 pictures.





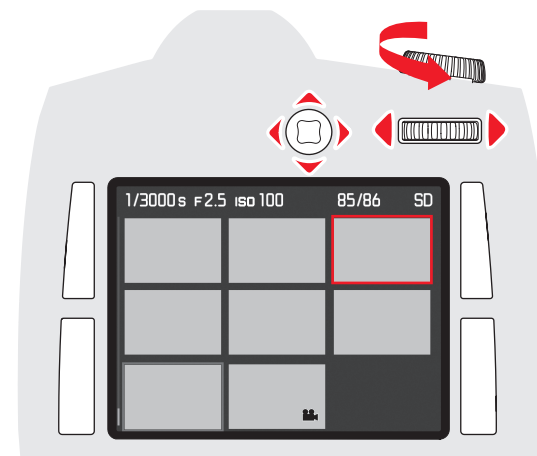

- The red frame marks the picture previously displayed in full size during the viewing of 4 or 9 pictures.

## SELECTION OF ONE OF THE REDUCED PICTURES

1. Select the desired picture by pressing the Joystick up, down, left or right
  - The frame changes to an endless loop in lines from picture to picture.
2. The framed picture can be enlarged in steps by turning the shutter speed setting dial to the right









## PROTECTING PICTURES / CLEARING DELETE PROTECTION

- Press any of the button top or bottom left, or top or bottom right of the monitor
  - In the image field the button functions valid in this situation are displayed - for 4 s - alongside the corresponding buttons  (Call up menu control),  (Call up delete menu),  (Call up protect menu) and  (Change view, see p. 47)
- Press the button marked  in this case
  - The image field displays:
    - The button functions valid in this situation **ALL**, **Back**, and **OK**, and **Protect single?** in the footer
    - Possibly the symbol  for a delete-protected picture.
- With the button top left of the monitor, select whether you wish to protect only the displayed picture or all the pictures, or (if one or more pictures is/are already protected) whether you wish to cancel the delete protection for the displayed picture or all the pictures
  - The corresponding displays change: Alongside the button between **ALL** and **SINGLE**, in the footer according to the situation.

### Notes:

- Even when protection or canceling of the delete protection of individual pictures is activated, you can enlarge the picture or call up other pictures.
  - Pressing the button marked **BACK** in this case (see above under 2.) returns you to the respective normal view.
- Press the **OK** button to protect the picture(s) or to cancel the delete protection.
    - The symbol  for a delete-protected picture appears or disappears in the monitor.

## DELETING PICTURES

- Press any of the button top or bottom left, or top or bottom right of the monitor
  - In the image field the button functions valid in this situation are displayed - for 4 s - alongside the corresponding buttons  (Call up menu control),  (Call up delete menu),  (Call up protect menu) and  (Change view, see p. 47)
- Press the button marked  in this case
  - The image field displays
    - the button functions valid in this situation **ALL**, **BACK**, and **OK**, and **Delete single?** in the footer.
    - Possibly the symbol  for a delete-protected picture.
- With the button top left of the monitor, select whether you wish to delete only the displayed picture or all the pictures
  - The corresponding displays change: Alongside the button between **ALL** and **SINGLE**, in the footer according to the situation.

### Notes:

- When deletion is activated, you can enlarge the picture or call up other pictures.
- Pressing the button marked **BACK** in this case (see above under 2.) returns you to the respective normal view.

### If only one picture is to be deleted

- Press the **OK** button to delete the picture(s).
  - The next undeleted picture appears in the monitor. If this was the only picture a message is displayed: **No media file to display**

## If all pictures are to be deleted

- Press the button marked **OK** in this case.
  - A safety confirmation prompt appears on the monitor: **Delete all?**

### Notes:

- Pressing the button marked **i** in this case (see above under 2.) returns you to the respective normal view.
  - Protected pictures are not deleted. After deletion, the last (highest number) of the undeleted pictures appears.
- Confirm and start the deletion with the **OK** button.
    - A message appears in the monitor: **No media file to display**

## ADDITIONAL FUNCTIONS

### TRANSFERRING DATA TO A COMPUTER

The Leica S is equipped with a USB 3.0 interface for transferring data to a computer. This allows fast data transfer to computers with the same kind of interface. The computer used must either have a USB port (for direct connection of the Leica S), or be equipped with a card scanner for CF or SD/SDHC/SDXC cards. Furthermore, an up-to-date USB 3.0 driver must be installed

If the Leica S is connected to the computer with the LEMO® USB 3.0 cable, it is automatically recognized by the operating system. Use the Windows® Explorer to copy/save the picture data to your computer.

#### Note:

Apple® Mac® computers allow the transfer of video files only up to a maximum file size of 4 GB. If larger video files are copied, an error message is displayed.

#### Important:

- Use only the LEMO® USB cable supplied.
- While data is being transferred from the Leica S to the computer, the connection may not under any circumstances be broken by removing the USB cable, as otherwise the computer and/or the Leica S may crash, and the memory card may even be irreparably damaged.
- While data is being transferred from the Leica S to the computer, the camera must not be turned off or turn itself off due to a lack of battery capacity, as otherwise the computer can crash. For the same reason the battery must never be removed from the camera while the connection is active. If the battery capacity is about to run out during data transfer, stop the data transfer, turn off the camera (see p. 15) and charge the battery (see p. 8).

### Connecting and transferring the data using card scanners

The picture data can be transferred to a computer using a commercially available card scanner for CF or SD/SDHC/SDXC memory cards. These devices, as well as further information, can be obtained in a computer accessories store.

### Data structure on the memory card

The **100LEICA**, **101LEICA**, etc. folders can each hold up to 9999 pictures.

### Leica Image Shuttle®

The exclusive Leica Image Shuttle software enables you to remotely control the camera from a computer and to directly store the image data on the computer's hard drive for "tethered shooting". All of the key camera functions can be controlled. This convenient solution provides ideal support in the studio and on location.

Leica Image Shuttle is available as a free download when you register your Leica S on the Leica Camera AG website. Further details on the download of the two programs can be found on the registration card in the camera packaging.

### System requirements

Microsoft® Windows® Vista® / 7; Mac OS X 10.6 or higher. In some Windows versions it is possible that the operating system will display a warning about a missing Windows signature. Please ignore this message and continue with the installation.

### Installing firmware updates

Leica is constantly working on developing and optimizing its products. As digital cameras have many functions that are purely controlled electronically, some of these improvements and enhancements to the functions can be installed on the camera at a later date. Leica provides firmware updates at irregular intervals for this purpose. Information about any resulting changes or additions to the details in this manual can be found at:

<http://www.s.leica-camera.com/downloads-overview>

You can check in the sub-menu of menu item **Camera Information** whether your camera and/or the attached lens has the latest firmware version (see also pp. 16-19 and 66).

You can easily download new firmware yourself from our website and install it on your camera.

1. Format a memory card in your Leica S
2. Switch off the camera and insert the card into a card scanner – either integrated or connected to your computer. (A scanner is required for firmware updates)
3. Download the firmware file under the link:  
<https://owners.leica-camera.com/login>
4. Save the firmware file S-X\_XXX.FW to the highest level of the card folder structure. X\_XXX stands for the relevant version.
5. Eject the card properly from your card scanner, insert it into the camera and close the cover.
6. Turn on the camera
7. In the menu, under **SETUP**, select the item **Camera Information**
  - If the camera detects a newer firmware version than the one installed, this will be indicated in the respective line (**Camera** or **Lens**) by characters in front of and behind the firmware number.
8. Open the corresponding sub-menu
  - Apart from the two version numbers, the sub-menu contains a confirmation prompt.
9. Start the update with **Yes** or reject with **No**
  - A progress screen appears during the process.
  - The update process begins. This can take several minutes.
  - After a successful update, a corresponding message is displayed for confirmation.

#### Note:

If the battery is not charged sufficiently, a corresponding warning message is displayed.

## WIRELESS DATA TRANSMISSION AND REMOTE CONTROL OF THE CAMERA

You can control the camera remotely using a smartphone/tablet or use the smartphone/tablet as an external storage medium. In order to do this, the Leica S app must first be installed on your smartphone. This app is available in the Apple App Store™ for iOS™ devices.

### WLAN settings

1. In the menu, under **SETUP**, select the item **WLAN** and
2. activate **WLAN Connection** in the sub-menu

### Create personal password

For security reasons you should change the default password for the connection to your Leica S. The data are encrypted with the WPA2 standard during the data transfer.

1. In the **WLAN** sub-menu, select **Network Key**

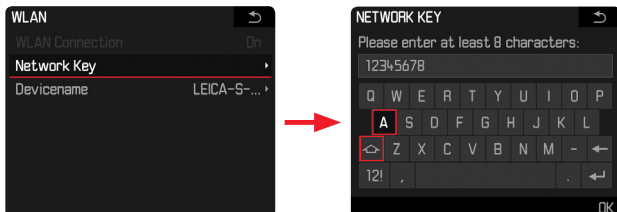

2. Enter the characters for your personalized password using the Joystick or the rear thumbwheel
3. Press the button marked **OK**

### Change device name (SSID)

You can change the device name (SSID) of the camera. A name has already been assigned here at the factory (LEICA-S...).

1. In the **WLAN** sub-menu, select **Device Name**



2. Enter the characters for your personalized device name using the Joystick or the rear thumbwheel
3. Press the button marked **OK**

### Create connection to the camera

(Settings are made at the smartphone/tablet)

1. Select the camera from the list of available WiFi networks
2. Enter the camera password

### Data transfer and remote control

1. Start the app on your smartphone/tablet
2. Create connection to the camera
3. Execute the desired function using the app

### Notes:

- When using devices or computing systems that require more reliable security than WLAN devices, appropriate measures must be taken to ensure security and protect against disruptions to the systems used.
- Leica Camera AG accepts no liability for damage arising from the use of the camera for purposes other than as a WLAN device.
- It is assumed that the WLAN function will be used in the countries where this camera is sold. If used in other countries than the one where the camera is sold, there is the risk that communications transmission conditions may be violated. Leica Camera AG assumes no responsibility for violations of this kind.
- Please also notice that data transmitted and received wirelessly may be intercepted by third parties. We highly recommend that you activate encryption in the wireless access point settings in order to ensure that the information is secure.
- Don't use the camera in places where there are magnetic fields, static electricity, or disturbances, such as near microwaves. Otherwise the wireless transmissions may not reach the camera.
- Using the camera near devices such as microwaves or cordless telephones that use the 2.4 GHz radio frequency wavelength may negatively affect the performance of both devices.
- Do not connect to wireless networks you are not authorized to use.
- When the WLAN function is activated, the device will automatically search for wireless networks. When this happens, networks that you are not authorized to use (SSID: indicates the name used to identify a network over a WLAN connection) may be displayed. Do not attempt to connect to such a network, since this would be seen as unauthorized access.

## MISCELLANEOUS

### LEICA SYSTEM ACCESSORIES

#### Interchangeable lenses

The range of interchangeable lenses in the Leica S system covers focal lengths from wide angle to telephoto, including a macro lens for close-ups. Some models may be available with the option of an integral central shutter – for flash photography with sync speeds up to 1/1000 s. All Leica S lenses are characterized by a high light intensity – in relation to the picture format, and always by maximum imaging performance.

#### S ADAPTER

The Leica S adapter allows the use of lenses from other manufacturers with Leica S cameras. The three purely mechanical bayonet adapters transmit no mechanical or electrical controls, signals or data between housing and lens. There is also a further Leica S adapter for use with Hasselblad HC/HCD lenses and one for the use of the Contax 645 lens on Leica S cameras that allow the use of all the functions of these lenses.

Leica S Adapter V ..... (for lenses from the Hasselblad V system)	Order No. 16 024
Leica S Adapter M645..... (for lenses from the Mamiya 645 system)	Order No. 16 025
Leica S Adapter P67..... (for lenses from the Pentax 67 system)	Order No. 16 026
Leica S Adapter H ..... (for lenses from the Hasselblad H system)	Order No. 16 030
Leica S Adapter C ..... (for lenses from the Contax 645 system)	Order No. 16 038

#### Interchangeable focusing screens

Interchangeable focusing screens are available for the Leica S. They are delivered individually in a case with changing tweezers and a dust brush. Completely matt screen ..... Order No. 16 000  
(Standard, supplied with the camera)  
Matt screen with microprism ring and wedge..... Order No. 16 001  
Completely matt screen with grid lines ..... Order No. 16 002

#### Multifunction S hand grip

The multifunction grip simplifies handling for portrait format pictures thanks to its form and appropriately positioned operating elements. It also allows the use of an additional battery to increase the capacity. Its attachment – with tripod screw – is quick and easy. (Order No. 16 028)

#### Grip strap S

The grip strap S is fastened to the multifunction hand grip and significantly simplifies the carrying and holding of the camera/hand grip combination. (Order No. 16 004)

#### Professional charger S

This charger allows you to significantly boost and safeguard the availability of your Leica S system: It can charge two batteries at the same time. (Order No. 16 011)

#### AC adapter S (power pack)

If the Leica S (Typ 007) is used in a fixed position and/or for a very large number of pictures over a prolonged period, and particularly when it cannot be monitored, then it is expedient to ensure a continuous power supply by using this power pack. (Order No. 16 041)

#### Note:

The power pack S (Order No. 16 022) cannot be used with the Leica S (Typ 007).

#### Flash units

The Leica SF 26 system flash unit is characterized by very simple operation. (Order No. 14 622)

#### Remote cord S

The electric remote cord S is highly recommended where maximum jitter-free photography is demanded. (Order No. 16 029)

#### HDMI cable

The HDMI cable allows exceptionally fast transfer of picture data to display equipment with corresponding HDMI sockets. Length = 1.5 m (Order No. 14 491)

#### Audio adapter S

The audio adapter S that is connected to the camera via LEMO plug allows the simultaneous connection of headphones and a microphone (both with 3.5 mm jack). (Order No. 16 042)

#### SPARE PARTS

#### Order No.

Camera bayonet cover S .....	16 021
Carrying strap S.....	16 037
Standard focusing screen.....	16 000
Viewfinder cover .....	16 015
Li-Ion Battery S BP-PRO1 .....	16 039
Quick Charger S (with integrated USA mains plug and EU, UK and AUS interchangeable mains plugs, car charging cable)	16 009

## PRECAUTIONS AND CARE INSTRUCTIONS

### GENERAL PRECAUTIONS

Do not use your Leica S in the immediate vicinity of devices with powerful magnetic, electrostatic or electromagnetic fields (e.g. induction ovens, microwave ovens, television sets or computer monitors, video game consoles, cell phones, radio equipment).

- If you place the Leica S on or very close to a television set, its magnetic field could interfere with picture recordings.
- The same applies for use in the vicinity of cell phones.
- Strong magnetic fields, e.g. from speakers or large electric motors, can damage the stored data or the pictures.
- If the Leica S malfunctions due to the effects of electromagnetic fields then turn the camera off, remove the battery, and then turn the camera on again after reinserting the battery. Do not use the Leica S in the immediate vicinity of radio transmitters or high-voltage power lines.
- Their magnetic fields can also interfere with picture recordings. Protect the Leica S from contact with insect sprays and other aggressive chemicals. Petroleum spirit, thinner and alcohol may not be used for cleaning.
- Certain chemicals and liquids can damage the housing of the Leica S or the surface coating.
- As rubber and plastics sometimes emit aggressive chemicals, they should not remain in contact with the Leica S for a long time. The Leica S is protected against moisture and dust to a certain extent by a number of design measures. Ensure nevertheless that neither water, sand nor dust can get into the camera, e.g. when it is snowing or raining or on the beach.
- Sand and dust can damage the camera and memory cards. Take particular care when changing lenses and when inserting and removing the cards. If moisture does get in, it can cause malfunctions and even permanent damage to the Leica S and the memory cards. If salt water spray gets onto the Leica S, wet a soft cloth with tap water, wring it out thoroughly and wipe the camera with it. Then wipe down thoroughly with a dry cloth.

### MONITOR AND TOP PANEL DISPLAY

- If the Leica S is exposed to significant temperature fluctuations, condensation can form on the displays. Wipe it off carefully with a soft dry cloth.
- If the Leica S is very cold when it is turned on, the displays may at first appear darker than usual. As soon as they warm up, they will reach their normal level of brightness. The monitor is manufactured using a high-precision process. This ensures that, of the total of around 921,600 pixels, more than 99.995% work correctly and only 0.005% remain dark or are always bright. However, this is not a malfunction and it does not impair the reproduction of the picture.

### SENSOR

Cosmic radiation (e.g. on flights) can cause pixel defects.

### CONDENSATION

If condensation has formed on or in the Leica S, you should turn it off and leave it to stand at room temperature for around an hour. Once the camera temperature has adjusted to room temperature, the condensation will disappear by itself.

## CARE INSTRUCTIONS

- As any soiling also represents a growth medium for microorganisms, you should take care to keep the equipment clean.

### FOR THE CAMERA

- Clean the Leica S only with a soft, dry cloth. Stubborn dirt should first of all be covered with a well-thinned cleaning agent and then wiped off with a dry cloth.
- To remove stains and fingerprints, the camera and lenses should be wiped with a clean lint-free cloth. Tougher dirt in hard to reach corners of the camera body can be removed with a small brush. Take care not to damage the shutter blades and mirror surface, e.g. with the shaft of the brush.
- All mechanically operated bearings and sliding surfaces on your Leica S are lubricated. Please remember this if you will not be using the camera for a long period of time. To prevent the lubrication points becoming gummed up, the camera shutter should be released a number of times every three months. It is also recommended that you repeatedly move and use all other controls.

### FOR LENSES

- Dust on the outside of the lens should be removed only with a soft-haired brush or a soft, clean, dry microfiber cloth. This cloth is included in the scope of supply of this lens. If stains and finger have to be removed, use such a cloth and clean carefully with a circular movement starting at the center of the lens and working towards the edge. The Leica Aquadura coating allows simple cleaning. Do not apply any high pressure in order to maintain this property for as long as possible. On no account may acetone be used for cleaning.
- For optimum front lens protection in unfavorable photographic conditions (e.g. sand, salt water spray), use transparent UVa filters. However, you should bear in mind that, like all filters, they can cause unwanted reflections in certain backlight situations and with high contrasts. The generally recommended lens hood also protects the lens from unintentional fingerprints and the rain.

### FOR THE BATTERY

Rechargeable lithium ion batteries generate power through internal chemical reactions. These reactions are also influenced by the ambient temperature and humidity. Very high and low temperatures shorten the operating time and service life of the batteries.

- Always remove the battery if you will not be using the Leica S for a longer period of time. Otherwise after several weeks the battery could undergo deep discharge, i.e. the voltage is sharply reduced, as the Leica S still consumes a small amount of current (e.g. for saving date and time) even when it is turned off.
- Lithium ion batteries should only be stored in a partially charged condition, i.e. not completely discharged or fully charged (in the corresponding display in the top panel display). For very long storage periods, you should charge the battery for approx. 15 minutes roughly twice a year to avoid a deep discharge.
- Always ensure that the battery contacts are clean and freely accessible. Whilst lithium ion batteries are proof against short circuits, they should still be protected against contact with metal objects such as paper clips or jewelry. A short-circuited battery can get very hot and cause severe burns.
- If a battery is dropped, check the casing and the contacts immediately for any damage. Using a damaged battery can damage the Leica S.
- Batteries have a limited service life.
- Take damaged batteries to a collection point to ensure correct recycling.
- Never throw batteries into a fire as this can cause them to explode.

## FOR THE CHARGER

- If the charger is used in the vicinity of radio receivers, it can interfere with the reception; make sure there is a distance of at least 1 m between the devices.
- When the charger is in use, it can make a noise (buzzing) – this is quite normal and is not a malfunction.
- When it is not in use, disconnect the charger from the mains as otherwise it uses a certain (very small) amount of power even when no battery is inserted in it.
- Always keep the charger contacts clean, and never short circuit them.

## FOR MEMORY CARDS

- Whilst a picture is being stored or the memory card is being read, it may not be removed, nor may the Leica S be turned off or exposed to vibrations.
- For safety, memory cards should only ever be stored in the anti-static cover supplied.
- Do not store memory cards where they will be exposed to high temperatures, direct sunlight, magnetic fields or static discharge.
- Do not drop or bend memory cards as this can damage them and result in loss of the stored data.
- Always remove the memory cards if you will not be using the Leica S for a longer period of time.
- Do not touch the connections on the memory card and keep them free of dirt, dust and moisture.
- It is recommended that the memory cards are reformatted from time to time, as fragmentation occurs when deleting, which can block some of the memory capacity.

## CLEANING THE SENSOR

If any dust or dirt particles should adhere to the sensor cover glass, depending on the size of the particles this can be identified by dark spots or marks on the pictures.

The Leica S can be returned to Leica Camera AG Customer Service (address: see p. 67) for chargeable cleaning of the sensor; this cleaning is not covered by warranty. You can also carry out cleaning yourself, using the **Sensor Cleaning** function in the menu. This allows access to the sensor by keeping the shutter open.

### Notes:

- Generally: To protect the Leica S against ingress of dust etc. into the interior of the camera, it is important always to have a lens or a cover fitted to the camera body.
- For the same reason, when changing lenses work quickly and in an environment that is as dust-free as possible.
- As plastic parts can easily pick up a static charge and then attract more dust, individual lens caps and covers should only be stored for short periods in pockets in clothing.

### Setting the function

1. In the menu under **SETUP**, select **(Sensor Cleaning)**
  - The relevant sub-menu appears.
2. Confirm with **Yes**
  - The mirror is folded up and the shutter opens.
3. Carry out cleaning. Make sure you follow the instructions under "Notes" below.
4. After cleaning, the shutter is closed again by turning off the camera.
  - The message **Please stop sensor cleaning immediately** is displayed.

### Notes:

- This function is only available when the battery has at least 50% of its full capacity. Otherwise a corresponding warning is displayed.
- As far as possible, both inspection and cleaning of the sensor should be performed in a dust-free environment to prevent further soiling.
- An 8x or 10x magnifying glass is very helpful during the inspection before and after cleaning.
- Lightly adhering dust can be blown off the sensor cover glass using clean and, if necessary ionized gases such as air or nitrogen. It makes sense to use a (rubber) bellows with no brush for this purpose. Special, low pressure cleaning sprays such as "Tetenal Antidust Professional" can also be used in line with their specified usage.
- If the particles cannot be removed in this way, please contact the Leica Product Support department.
- If the battery capacity falls to lower than 40% while the shutter is open, the warning message **"Attention Please stop sensor cleaning immediately"** appears in the monitor. At the same time a continuous beep tone will sound which can only be stopped by turning off the camera. Turning the camera off will cause the shutter to be closed again. Be absolutely sure in this case that the shutter window is clear, i.e. that no object can obstruct the closing movement of the shutter, otherwise damage may occur.

### Important:

- Leica Camera AG accepts no liability for damage caused by the user when cleaning the sensor.
- Do not attempt to blow dust particles off the sensor cover glass using your mouth; even tiny droplets of saliva can cause marks that are difficult to remove.
- Compressed air cleaners with high gas pressure may not be used as they can also cause damage.
- Take care to avoid touching the sensor surface with a hard object during inspection and cleaning.

### Storage

- If you will not be using the Leica S for a longer period of time, we recommend that you
  - a. Switch it off (see p. 15),
  - b. Remove the memory cards (see p. 12), and
  - c. Take out the battery (see p. 11), (the entered time and date are lost after max. 3 months, see p. 20).
- A lens acts like a magnifying glass if bright sunlight shines on the front of the camera. The camera must therefore never be set aside in strong sunlight without protection. Using the lens cover and keeping the camera in the shade (or immediately putting it away in the case) help to prevent damage to the interior of the camera.
- Store the Leica S in a dry, adequately ventilated place, where neither high temperatures nor high humidity will occur. When used in humid conditions, the Leica S should be completely free of all moisture before being stored away.
- Photo cases that became wet during use should be emptied to prevent damage to your equipment caused by moisture and any leather-tanning residue released.
- To prevent fungal growth during use in hot, humid tropical climates, the camera equipment should not be kept in air-tight containers for longer than absolutely necessary. This is only recommended if a desiccant such as silica gel is placed in the container
- To prevent the formation of fungus, do not store the Leica S in a leather case for long periods of time.
- In a dry environment, store the Leica S preferably in a closed and padded container so that nothing can rub against it and it is protected from dust.
- Note the serial numbers of your Leica S and lenses, as these are extremely important in case of loss.



## A

Accessories .....	53
Aperture priority.....	31
Aperture, setting.....	30
Autofocus	
Focus priority (AF-C).....	29
Shutter release priority (AF-L).....	29
Automatic program .....	30

## B

Battery	
Charge level displays.....	11
Charging .....	8
Inserting and removing.....	11

## C

Care instructions.....	54
Carrying strap .....	8
Cautions .....	54
Cleaning the sensor .....	55
Color space .....	22
Compression rate .....	22
Contrast, see Image properties .....	22

## D

Data structure on the memory card.....	51
Date .....	20
Deleting pictures.....	50
All pictures on the memory cards .....	50
Single pictures .....	50
Depth of field .....	35
Depth of field preview button .....	7/35
Designation of parts.....	7
Detail, selection of the, see Review mode.....	48
Displays	
In the monitor .....	62
In the top panel display .....	61
In the viewfinder.....	60
Distance setting.....	29
Depth of field.....	35
Metering field.....	29
Setting dial.....	7
DNG .....	22

## E

Exposure control / exposure metering	
Aperture priority.....	31
Automatic program .....	30
Bracketing .....	33
Center weighted metering .....	30
Exposure compensation .....	32
Manual settings.....	33
Metering memory lock .....	32
Multi-field metering .....	30
Program shift .....	31
Setting the operating mode .....	30
Setting the shutter speed / aperture .....	30
Shutter speed priority.....	31
Spot metering .....	30
Values above and below the metering range .....	34

## F

File format / compression rate.....	22
Firmware downloads .....	51
Flash mode	
Attaching a flash unit .....	40
Automatic computer .....	42
Flash connection socket .....	42
General.....	39
Linear flash (HSS) .....	41
Manual flash photography with constant flash power .....	42
Ready and indicator lamps .....	42
Stroboscope flash mode.....	41
Synchronization .....	40
Sync speed / sync speed range .....	40
TTL flash mode.....	41
X contact .....	42
Flash units .....	39/53
Focusing screens .....	13/53
Changing .....	13
Formatting of the memory card .....	37

## G

GPS .....	38
-----------	----



## H

Histogram .....	27/47
Horizon .....	28

## I

Image frequency .....	26
Image properties (contrast, sharpness, color saturation) .....	22
Info service, Leica Product Support .....	67
Interchangeable lenses .....	14/53
ISO sensitivity .....	24

## L

Lenses, Leica S .....	14/53
Fitting and removing .....	14
Linear flash, see under Flash mode	

## M

Main switch .....	7/15
Memory card settings .....	25
Memory cards	
Inserting and removing .....	11
Menu control .....	16
Menu language .....	20
Menu options .....	66
Mirror lock-up .....	35
Monitor .....	7/21
Setting the brightness .....	21

## N

Noise (key acknowledgment (response) tones) .....	21
---	----

## P

Package contents .....	6
Parts, designation of .....	7
Picture series .....	26
Power off, automatic .....	20
Protecting pictures / clearing delete protection .....	50

## R

Raw data / DNG .....	22
Repairs / Leica Customer Care .....	67
Resetting all custom menu settings .....	36
Resolution .....	22
Review mode .....	46
<b>Auto Review</b> function .....	46
Detail selection .....	48
Enlarging .....	48
<b>PLAY</b> function .....	46
Scrolling .....	48

## S

Saturation, see Image properties .....	22
Self-timer .....	34
Sensitivity .....	24
Sensor, cleaning .....	55
Setting the focus .....	29
Autofocus .....	29
Manual settings .....	29
Shutter release, see also shutter and technical data .....	26/68
Shutter speed priority .....	31
Shutter, see shutter release and technical data .....	26/59
Central shutter .....	14/15/39
Focal plane shutter .....	15
Shutter speed, setting .....	30
Spare parts .....	53
Storage of picture data .....	25
Storage of the Leica S .....	55

## T

Technical data .....	58
Thumbwheels .....	7/30
Time and date .....	20
Top panel display .....	7/61
Setting the brightness .....	21
Transferring data to a computer .....	51
Turning on / off .....	15
Auto Power Off .....	20

## U

USB port .....	51
----------------	----

## V

Video record button .....	7/44
Viewfinder	
Adjusting the eyepiece .....	15
Displays .....	60
Volume, setting the key acknowledgment (response) tones .....	21

## W

Warning messages .....	6
White balance .....	22
Automatic .....	23
By metering .....	23
Fixed settings .....	23
Manual .....	23

## TECHNICAL DATA

**Camera type** Leica S (Typ 007), medium-format digital SLR camera

**Lens attachment** Leica S bayonet

**Lens system** Leica S lenses

**Picture format / aspect ratio** 30 x 45mm / 2:3

**Image sensor / resolution** Leica CMOS sensor with 6 µm pixel size, with micro lenses, 37.5 MP

**Dynamic range** 15 aperture stops

**Color depth** 16 bits per pixel

**Deep-pass filter** None, maximum transfer of the focus, suppression of Moiré by external digital image processing on sensor

**Data formats** Photo: DNG (raw data), DNG + JPEG, JPEG

DNG /JPEG resolution DNG: 37.5 MP, JPEG: 37.5 MP, 9.3 MP, 2.3 MP

**File size** DNG: approx. 42 Mbyte, JPEG: approx. 1-16 Mbyte (depending on the resolution used and picture content), Video: Uninterrupted video recordings are possible up to a maximum length of 29 minutes, maximum file size for transfer to MAC computers: 4 GB

**Buffer memory** 2 GB, maximum number of pictures in series (depending on memory card used): DNG: max. 14, JPEG: unlimited

**Color spaces** Adobe® RGB, sRGB, ECI RGB 2.0

**White balance** Automatic, manual by metering, 8 presets, color temperature input

**Storage medium** CF cards (max. UDMA7), SD cards up to 2 GB, SDHC cards up to 32 GB, SDXC cards, memory cards with a capacity of less than 1 GB cannot be used, 4K video recordings can only be stored on SD cards

**Menu languages**

English, German, French, Italian, Spanish, Russian, Japanese, Traditional Chinese, Simplified Chinese, Korean, Portuguese

### Exposure control

**Exposure metering** Open aperture metering through the lens (TTL)

**Metering methods** Spot (3.5%), center-weighted, multi-field (5 fields)

**Metered value storage** By pressing the shutter button to the pressure point, storage for 1 picture of permanently with Joystick

**Exposure compensation** ±3EV (exposure values), can be set in half steps

**Automatic bracketing** Optionally 3 or 5 pictures, optionally ½ EV, 1EV, 2EV, 3EV deviation between the individual pictures, depending on the set operating mode, change of the exposures via aperture and/or shutter speed

**Metering range** (with aperture 2.5 and ISO100), spot metering: EV2.7 - 20, center-weighted and multi-field metering: EV1.2 - 20, Warning display in the viewfinder for values above and below the metering range  
Measuring cell for prevailing light Multi-field photo diode (permanent light metering)

**Sensitivities** ISO100, ISO200, ISO400, ISO800, ISO1600, ISO 3200, ISO6400, ISO 12500, Automatic

**Exposure operating modes** Automatic program with shift function (**P**), aperture priority (**A**), shutter speed priority (**T**), manual setting (**m**)

### Flash exposure control

**Flash unit connections** Accessory shoe with center and control contacts, LEMO® or standard flash connection socket without control of the light yield

**Synchronization** Flash sync speed:  $\frac{1}{125}$  s, or  $\frac{1}{1000}$  s for lenses with central shutter, slower shutter speeds can be used, either at the beginning or end of the exposure; flashes also with faster shutter speeds ( $\frac{1}{180}$  s -  $\frac{1}{4000}$  s) possible with correspondingly configured flash units (HSS mode)

**Flash metering cell** Multi-field photo diode

**Flash exposure metering / control (with system-compatible Leica flash units attached to the camera)** Control by flash unit with TTL pre-flash metering, with automatic transfer and allowance for sensitivity and set/controlled lens aperture, all exposure modes can be used, automatic matching of the flash light component to the ambient light

**Linear flash mode** (with system-compatible, appropriately configured Leica flash units, linear flash mode with TTL pre-flash metering and automatic TTL-HSS control) For flash photography with faster shutter speeds than the sync speed by firing several flashes in quick succession, automatic changeover to HSS flash mode if shutter speed is below sync speed

**Stroboscope flash mode** (several flashes fired during one picture) With flash operating modes **P** and **A** and system-compatible, appropriately configured Leica flash units automatic adaptation of the exposure time

**Flash lighting compensation** Can be set on appropriately configured flash units

**Displays during flash mode** Ready status by flashing or steady light of the flash symbol in the viewfinder

## Focusing

**Focus detection** Using phase detection method, in Live View mode on the basis of contrast

**Sensor / metering field** One central cross sensor, defined by cross-hair on the matt screen, in Live View mode the metering field can be freely positioned

**Operating modes** Optionally AFs (single) = focus priority, AFc (continuous) = shutter release priority, MF (manual), manual override of the automatic setting possible at any time

**Metered value storage** By pressing the shutter button to the pressure point, storage for 1 picture of permanently with Joystick

**Autofocus drive** In lenses

## Viewfinder system

**Eyepiece** High eyepoint viewfinder, diopter correction of -3 to +1 dpt possible at the viewfinder

**Viewfinder field** 98%

**Magnification** 0.87x with 70 mm lens with setting to infinity and 0 dpt.

**Focusing screens** Interchangeable, standard equipment: Matt screen with microprism ring and wedge

## Displays

**Viewfinder** LCD line under viewfinder image, illuminated, displays

**Top panel** Self-illuminating LCD

**Monitor** 3" color TFT LCD monitor with 16 million colors and 921,600 pixels, approx. 100% image field, max. 170° viewing angle, anti-reflex/anti-soiling protective glass (Corning® Gorilla Glas®), color space: sRGB

**Live View mode** Optionally with/without exposure simulation, spot metering field can be moved in the whole image field, linked to also freely movable AF metering field, display optionally with histogram and clipping, marking of clearly focused subjects (focus peaking), grid lines and horizon indicators, picture information

## Video mode

**Format, resolution, frame rate, color scanning** MOV (Motion JPEG), optionally Full HD (1080 x 1920) with 24, 25 or 30 fps or 4K (2160 x 4096) with 24 fps, 4:2:2

**Exposure control** As for photos

**Sound recording** In 48 kHz / 16 bit stereo, optionally with internal or external microphones, time code

**Miscellaneous** Display optionally with marking of clearly focused subjects (focus peaking), external playback via HDMI socket: Full HD video stream, 4K video recordings can only be stored on SD cards

## Shutter and shutter release

**Shutter** Selected with main switch, in camera: Microprocessor-controlled, metal plate focal plane shutter with vertical movement, in appropriately configured Leica CS lenses: Central shutter

**Shutter speeds** Manual setting (with **T** and **M**): 60 - 1/4000s in half steps (60-1/1000s with central shutter), B for long exposures up to maximum 60s, flash synchronization up to 1/250s (1/1000s with central shutter).

Automatic setting (with **P** and **A**): Steplessly from 60s to 1/4000s (60-1/1000s with central shutter),

Linear flashes with all faster shutter speeds than 1/250s possible (with appropriately configured Leica system flash units and HSS-compatible SCA 3002 standard flash units)

**Series/interval shooting** Picture series: approx. 3.5 pictures/s, max. 14 pictures in series with DNG, unlimited with JPEG, interval shooting: Time until start, number of pictures and interval can be selected

**Shutter button** Two position: Activation of exposure and focus metering and metered value storage - shutter release

**Self-times** Delay time either 2 s or 12 s, indicated by flashing LED on the front of the camera and corresponding display in the monitor

**Mirror lock-up** 1st pressure: Mirror is folded up, lens aperture is closed to the set value, 2nd pressure: Shutter is released

**Turning the camera on/off** With main switch on camera top panel, optionally auto power off after approx. 2/5/10 minutes

**Power supply** Rechargeable Li-Ion Battery, rated voltage 7.3 V, capacity 2300 mAh, capacity display in top panel display; charge current / voltage: DC 1250 mA / 7.4 V. Model number: BP-PRO1; Manufacturer: PT. VARTA Microbattery Indonesia; Made in Indonesia, permanent power supply possible using mains power pack (available as an accessory)

**Lithium-Ion Battery Charger** Quick Charger S; Inputs: 100-240 V AC, 50/60Hz, 200 mA, automatic switching, or 12/24 V DC, 1A; Output: Nominal 7.4 V DC, 1250 mA / max. 8.25 V, 1265 mA Model number: 9C94270; Manufacturer: Ansmann; Made in China

**GPS** Optional (not available everywhere due to country-specific legislation, i.e. enforced automatic shutdown in those countries), data are written to EXIF header in picture files

**WLAN** (802.11 n-Standard), Integrated into camera, camera control and picture monitoring possible with smartphone or tablet app

**Horizon** Metering with acceleration sensor, metering range: inclination (about transverse axis) and tilt (about longitudinal axis) each ±90°, measuring accuracy / display sensitivity: ≤1° at 0-40°C, display in monitor

## Camera body

**Material** All-metal die cast magnesium body with non-slip plastic coating, top panel of magnesium, bottom cover of aluminum, bayonet of stainless steel

**Tripod thread** A 1/4 (1/4") DIN and A 3/8 (3/8") DIN (steel inserts) each with twist lock to DIN 4503, in metal tripod plate, under the center of the lens axis

**Operating conditions** 0 to +45°C, 15%-80% relative humidity

**Interfaces** ISO accessory shoe with additional control contacts and bore for locking pin, HDMI socket Type C, LEMO® jack for data output (USB 3.0 standard), 9-pin LEMO® jack for remote control accessory / remote flash trigger, audio out/in possible with audio adapter (available as an accessory)

**Dimensions** (width x depth x height) approx. 160 x 80 x 120 mm

**Weight** approx. 1260 g (with battery)

**Package contents** Charger 100-240 V with integrated USA mains plug, and interchangeable mains plugs (Euro, GB, AUS) and car charging cable, lithium ion battery, carrying strap, bayonet cover, eyepiece cover, image processing software: can be downloaded from the Leica Camera AG website after registration of the camera

## THE DISPLAYS

## IN THE VIEWFINDER

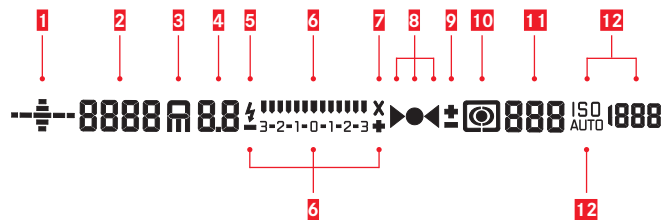
**1 Horizon**

(Tilting about the longitudinal axis/inclination about the transverse axis; values apply as examples for inclination in clockwise direction; other directions are shown analogously)

- max.  $\pm 0.5^\circ$
- 0.5-2.5°
- 2.5-5°
- 5-10°
- flashing  $\geq 10^\circ$

**2 Shutter speed/exposure time**

- Manually set value for **m** and **t**, automatically controlled value for **A** and **P**; display in half steps, or
- **HI** (high) or **LO** (low) for overexposure or underexposure in the automatic exposure modes **A**, **P**, **t** and by flash light, or **LO** for values below the metering range.
- **b** or **B** setting for long exposures
- **CArd** Warning message for full memory card(s)

**3 Exposure operating mode**

- **P** Automatic program
- **A** Aperture priority
- **t** Shutter speed priority
- **m** Manual setting of shutter speed and aperture

**4 Aperture**

Manually set value for **m** and **A**, automatically controlled value for **t** and **P**; display in half steps

**5 Flash display**

Lit Ready  
Flashing Flash charging, not ready

**6 Light scale**

(Marks: each  $\frac{1}{2}$ EV step, last marks/figures flash at  $\leq -3$ EV/ $\geq +3$ EV )  
to indicate

- Manual exposure compensation,
- Deviation of the current metering from the stored exposure setting (with metered value storage in the automatic exposure modes **A**, **P**, **t**)
- Exposure compensation

**7 Flash display**

Lit = Shutter speed set  $\geq$  sync speed

**8 Focus displays**

- Appears only in manual mode or in the case of manual override of the AF: Lights up continuously if the distance is set too far
- In manual mode: Lights up continuously with correct setting
  - With **AFc**: Lights up continuously with correct setting, flashes if correct setting is not possible,
  - With **AFc**: Lights up continuously with correct setting, goes out if focusing is restarted
- Appears only in manual mode or in the case of manual override of the AF: Lights up continuously if the distance is set too short

**9 Exposure compensation / flash exposure compensation set****10 Exposure metering method**

- Multi-field metering
- Center weighted metering
- Spot metering

**11 Picture counter**

- **999** Total remaining number of pictures
- **USB** External storage
- **0** (flashing with 2 Hz) = Memory card full
- **---** (flashing with 2 Hz) = No memory card inserted
- **L** Maximum number for picture series
- **Err** Error message

**12 ISO sensitivity**

- **ISO** For manual setting
- **ISO AUTO** For automatic setting
- **1600 HI 1 (ISO3200) / HI 2 (ISO6400) / HI 3 (ISO12500)=** Currently set sensitivity

**Note:**

The viewfinder LCD is always lit when the camera is switched on. The brightness of this lighting is automatically adapted to the ambient brightness for optimum legibility.

## THE DISPLAYS

### IN THE TOP PANEL DISPLAY

#### Starting view





(appears for approx. 5 s after turning on the camera)

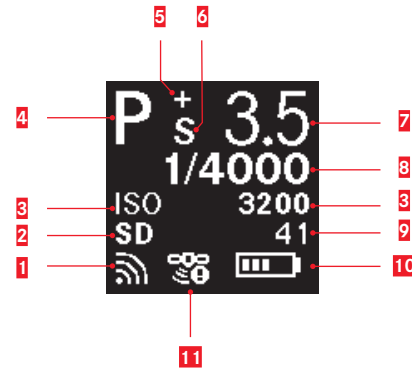

- 1** Time
- 2** Date
- 3** Camera / memory card status
  - **READY** Ready for recording
  - **CARD SEARCH** Memory card check
  - No legible memory card detected
- 4** Battery capacity (right for battery in camera, left for battery in hand grip) or symbol  for connected AC power pack adapter S

#### Standard view



- 1** WLAN activated
- 2** Memory card used
- 3** ISO sensitivity,  alternatively interval shooting set
- 4** Exposure operating mode
- 5** Exposure compensation set
- 6** Program shift set
- 7** Aperture
- 8** Shutter speed
- 9** Picture counter
- 10** Battery capacity (right for battery in camera, left for battery in hand grip) or symbol  for connected AC power pack adapter S
- 11** GPS
  -  Last position determined up to 6 minutes ago
  -  Last position determined up to 24 hours ago
  -  No position data available

#### Depth of field indicator

(for manual distance setting, press shutter button to 1st pressure point)

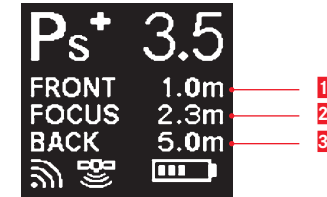

- 1** Front limit of the depth of field range
- 2** Set focal plane
- 3** Rear limit of the depth of field range

#### Display when setting the exposure operating mode

(appears only briefly after holding the rear thumbwheel depressed)



## THE DISPLAYS

## IN THE MONITOR

## Photo recording mode

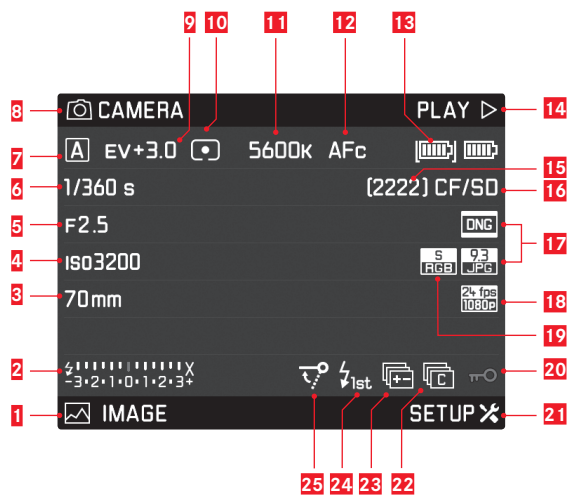

- 1** Function of the button bottom left
- 2** Flash ready indicator, light balance, flash sync speed indicator
- 3** Focal length
- 4** ISO sensitivity/setting
- 5** Aperture
- 6** Shutter speed
- 7** Exposure operating mode
- 8** Function of the button top left
- 9** Exposure compensation
- 10** Exposure metering method
- 11** White balance setting
- 12** Autofocus mode
- 13** Battery status / mains mode
- 14** Function of the button top right
- 15** Picture counter
- 16** Memory card(s) used
- 17** Photo file format / JPEG resolution
- 18** Video resolution / frame rate
- 19** Color space
- 20** Button lock activated
- 21** Function of the button bottom right
- 22** Symbol for
  - Single picture
  - Picture series
  - Interval shooting
  - Self-timer mode
- 23** Exposure bracketing activated
- 24** Flash trigger point
- 25** Mirror lock-up activated

## Recording mode Live View photo

## Standard view

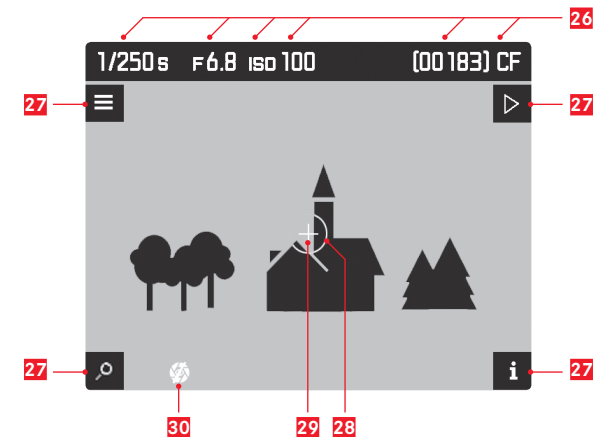

- 26** see **6, 5, 4, 15, 16**
- 27** Button functions (appear - in all Live View screens - for approx. 3 s after pressing any of the four buttons next to the monitor)
  - Magnification function
  - Menu control
  - Review mode
  - Change views
- 28** Spot exposure metering field
- 29** Autofocus metering field
- 30** Exposure simulation deactivated

## Standard view plus additional displays

### A Histogram and clipping indicators

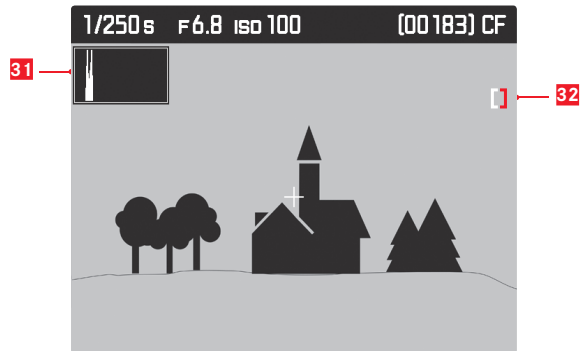

- 31 Histogram
- 32 Clipping symbol

### B Focus display (peaking)

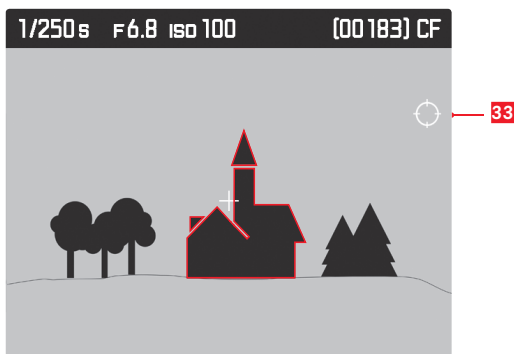

- 33 Peaking symbol

### C Grid and horizon

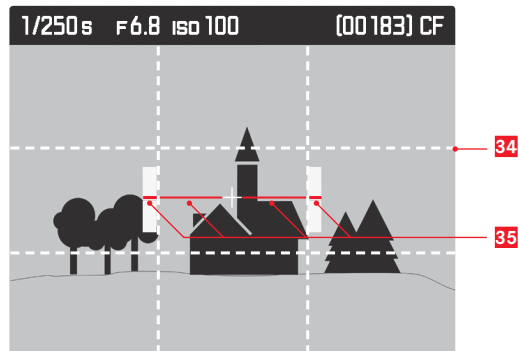

- 34 Grid lines
- 35 Horizon

### D Additional picture data

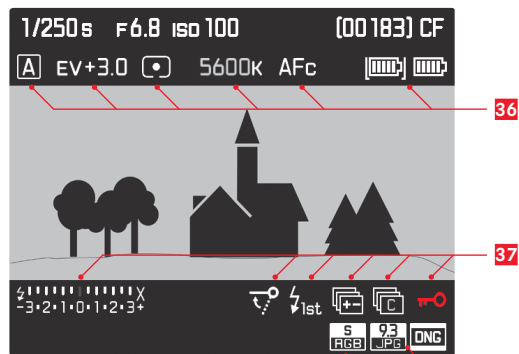

- 36 see 7, 9, 10, 11, 12, 13
- 37 see 2, 25, 24, 23, 22, 20
- 38 see 19, 17

## Video recording mode

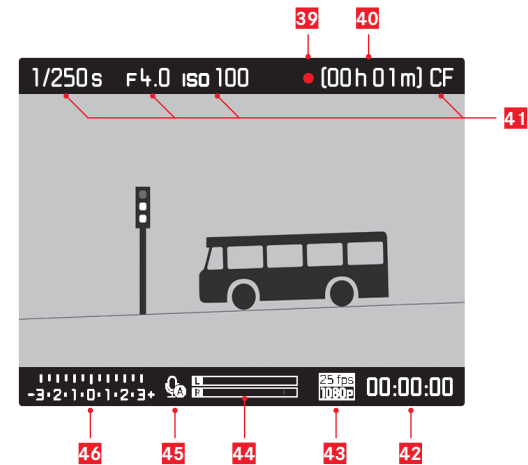

- 39 Indication of a recording in progress
- 40 Possible recording time
- 41 see 6, 5, 4, 16
- 42 Current recording time
- 43 Video resolution / frame rate
- 44 Audio recording level display
- 45 Sound recording mode
  - Automatic recording level control
  - Manual recording level control
  - Sound recording deactivated
- 46 Light scale, or headphone volume  
Volume off (mute)

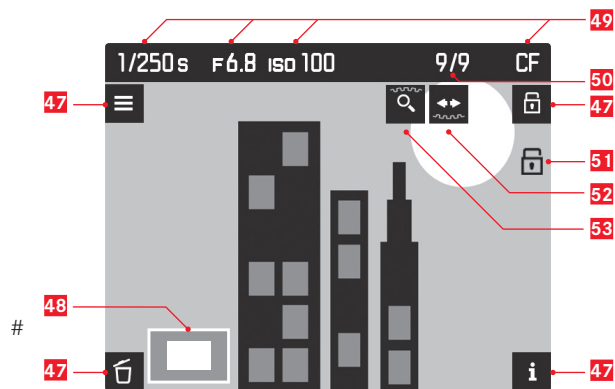
**Photo review mode****Standard view****47** Button functions

(appear when switching on Review mode in all photo and video views or after pressing any of the four buttons next to the monitor, disappear after approx. 3 s)

- Delete menu
- Menu control
- Protect menu
- Change views

**48** Detail size and position

see **6, 5, 4, 16**

**50** Number of picture displayed / total number of pictures**51** Symbol for delete-protected pictures**52** Operating instructions for scroll function (shutter speed setting dial)

(**52** and **53** appear / disappear together with **47**)

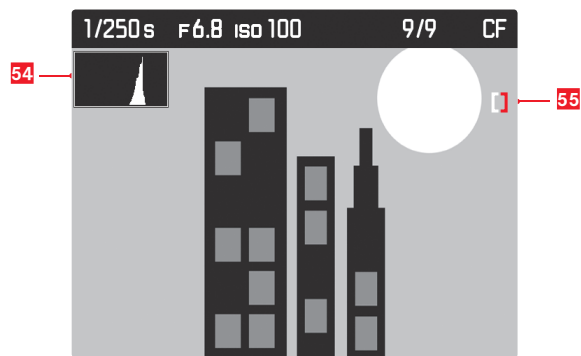
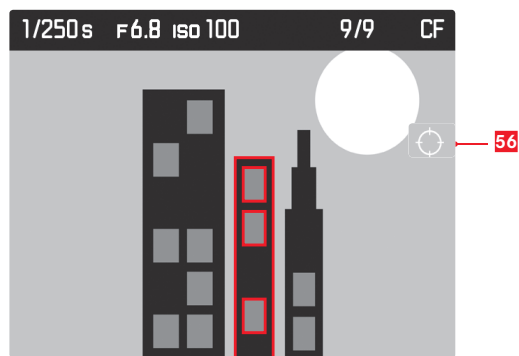
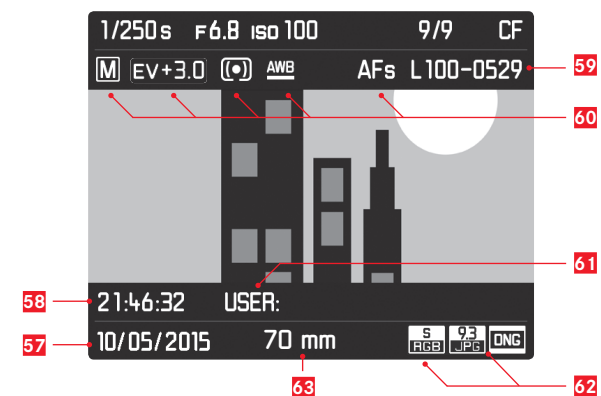
**53** Operating instructions for enlargement function (rear thumbwheel)**Standard view plus additional displays****A** Histogram and clipping indicator**54** Histogram**55** Clipping symbol**B** Focus display (peaking)**56** Peaking symbol**D** Additional picture data**57** Date of picture**58** Time of picture**59** Image file number**60** see **7, 9, 10, 11, 12****61** Profile memory slot**62** see **19, 17****63** Employed focal length



## Video review mode



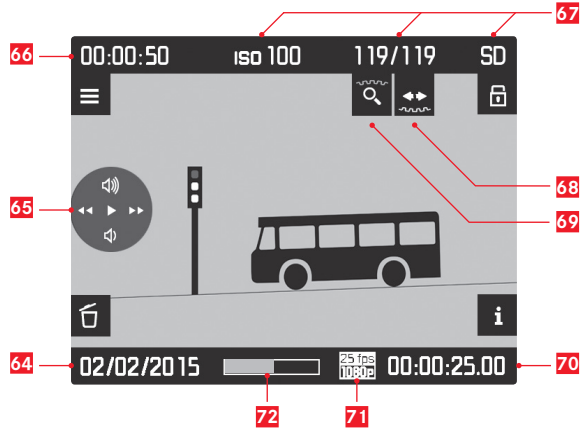

### Standard view



**64** Recording date and volume setting

Volume off (mute) , see also **65**

**65** Video control symbols (for Joystick)

-  Playback (press forward)
-  Fast forward (press to right or hold depressed)
-  Fast rewind (press to left or hold depressed)
-  Volume: louder (press up or hold depressed)
-  Volume: quieter (press down or hold depressed)

**66** Total recording time

**67** see **4, 50, 16**

**68** Operating instructions for scroll function (shutter speed setting dial)

**69** Operating instructions for enlargement function (rear thumbwheel)

**70** Elapsed playback time

**71** Video resolution / frame rate

**72** Elapsed playback time bar

### Standard view plus additional displays

#### A Histogram and clipping indicator

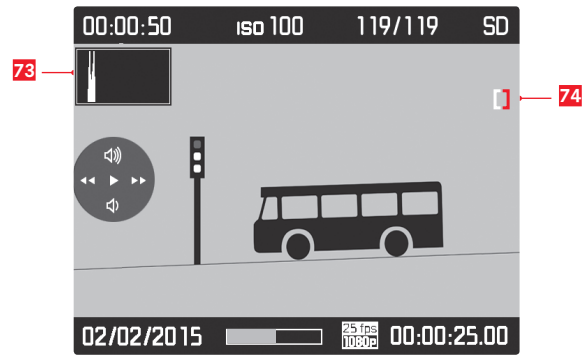

**73** Histogram

**74** Clipping symbol

#### B Focus display (peaking)

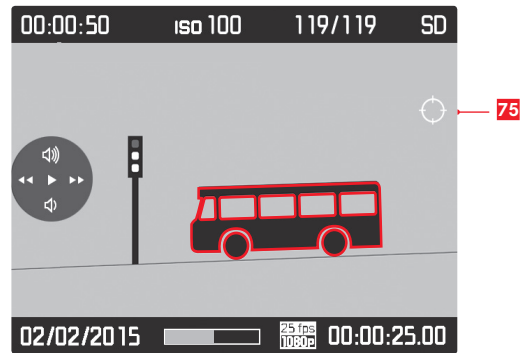

**75** Peaking symbol

#### C Additional picture data

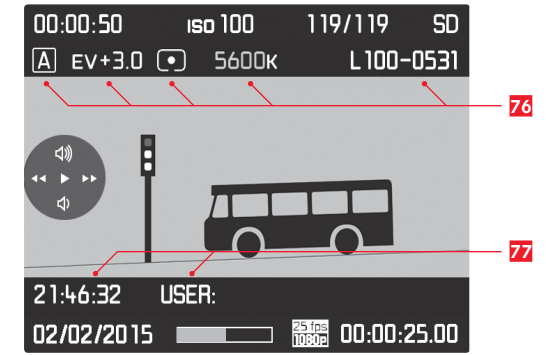



**76** see **7, 9, 10, 11, 59**

**77** see **58, 61**

## THE MENU OPTIONS

Area	Menu option	Page
 CAMERA	Drive mode	26/34
	Focus mode	29
	Exp. metering	30
	Exp. compensation	32
	Exp. bracketing	33
	Mirror up mode	35
	Max. flash sync. time	40

 IMAGE	ISO	24
	White balance	22
	Photo file format	22
	JPG resolution	22
	JPG settings	22
	Video resolution	43
	Video setting	43/45

Area	Menu option	Page
 SETUP	Storage backup (CF & SD)	25
	Format cards	37
	Image numbering	37
	Auto review	46
	Capture assistants	27/28/29/47
	Copyright information	38
	User profiles	36
	Auto ISO setup	24
	Flash sync. mode	40
	Keylock	30
	Customize controls	32
	Display brightness	21
	Acoustic signals	21
	Auto power saving	20
	WLAN	52
	GPS	38
	Date & time	20
	Language	20
	Reset camera	36
Sensor cleaning	55	
Camera information	2/51	

## LEICA PRODUCT SUPPORT

The Product Support Department at Leica AG can provide you with an answer to any technical questions relating to Leica products, including software supplied, either in writing, on the telephone, or by e-mail. They are also the contact point for purchasing advice and to order instruction manuals. Alternatively, you can send us your questions using the contact form on the Leica Camera AG homepage.

Leica Camera AG  
Product Support / Software Support  
Am Leitz-Park 5  
D-35578 Wetzlar, Germany  
Telephone: +49(0)6441-2080-111 /-108  
Fax: +49(0)6441-2080-490  
[info@leica-camera.com](mailto:info@leica-camera.com) / [software-support@leica-camera.com](mailto:software-support@leica-camera.com)

## LEICA CUSTOMER CARE

For servicing your Leica equipment or in the event of damage, the Leica Camera AG Customer Care department or the repair service provided by authorized Leica agents in your country are available (see the warranty card for a list of addresses).

Leica Camera AG  
Customer Care  
Am Leitz-Park 5  
D-35578 Wetzlar, Germany  
Telephone: +49(0)6441-2080-189  
Fax: +49(0)6441-2080-339  
[customer.care@leica-camera.com](mailto:customer.care@leica-camera.com)



my point of view

Leica Camera AG | Am Leitz-Park 5 | 35578 WETZLAR | DEUTSCHLAND  
Telefon +49 (0) 6441-2080-0 | Telefax +49 (0) 6441-2080-333 | [www.leica-camera.com](http://www.leica-camera.com)