



LEICA CL

QUICK START GUIDE



The comprehensive instructions are available at:

<https://en.leica-camera.com/Service-Support/Support/Downloads>

If you wish to receive a printed copy of the comprehensive instructions, please register at:

www.order-instructions.leica-camera.com

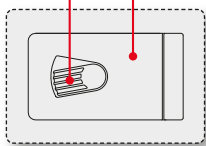
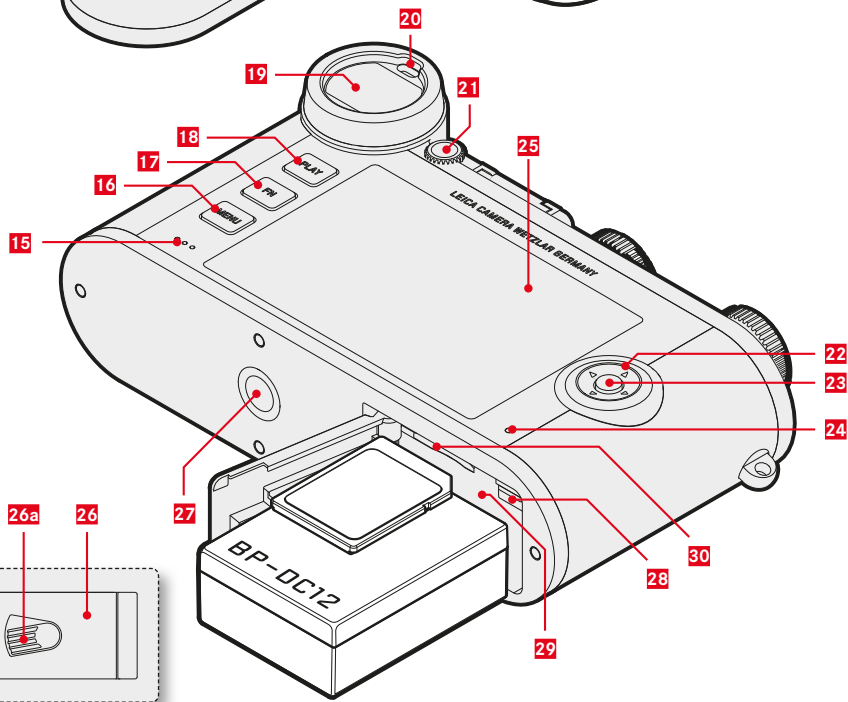
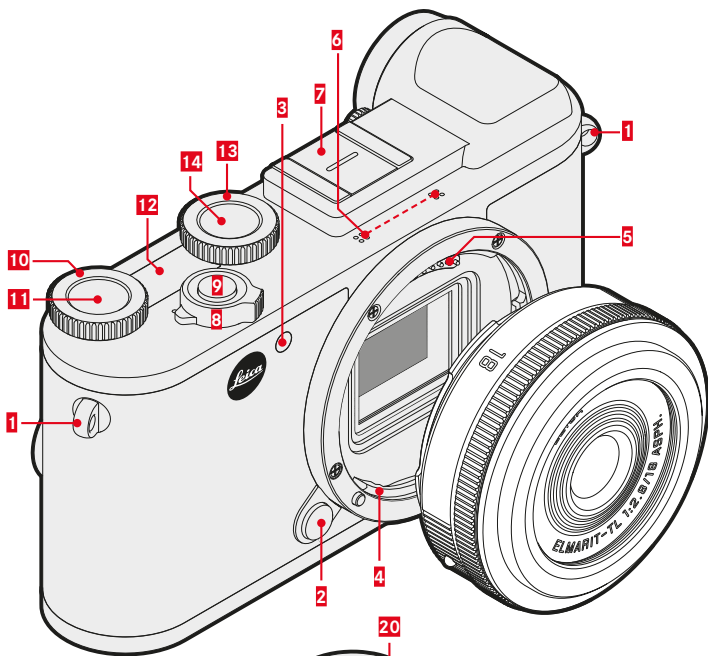

1 Strap lugs

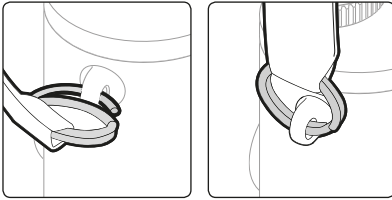

2 Lens release button

3 Self-timer LED / AF assist lamp

4 Leica L-Bayonet

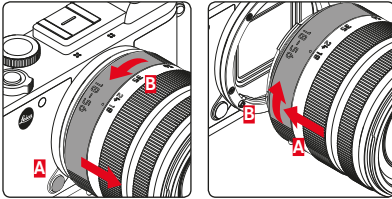

5 Contact strip

6 Microphones

Sound is recorded in stereo

7 Accessory shoe

Recommended flash units:

Leica system flash units SF 40, SF 64, and SF 58

8 Main switch

Turning the camera on and off

9 Shutter button

Pressing to the first pressure point activates:

- autofocus
- exposure metering and control

Pressing all the way down: takes a picture / starts/stops video recording

In standby mode:

The camera is reactivated

10/ 13 Setting wheels

- in the menu:

10 scrolls within the menu lists

- in review mode:

10 enlarges/reduces the recording and

13 browses

- in recording mode:

see table

11/ 14 Setting wheel buttons

- in recording mode:

11 calls up the right setting wheel's secondary function or the **FN** menu and

14 calls up the exposure mode

- in review mode:

11 enlarges/reduces a recording and

14 marks a recording

12 Top display

Indicates the exposure mode, aperture, shutter speed, in certain cases the set ISO and exposure compensation values

15 Speaker

16 MENU Button

17 FN Button

Direct access to menu functions

- in recording mode:

Direct access to assignable menu item list

- in recording and playback modes:

Direct delete function

18 PLAY Button

Switching between picture and review mode

19 Viewfinder

Resolution: 1024 x 768 pixels (2.36 MP)

Magnification 0.74x

20 Eye sensor

Automatic switching between viewfinder and monitor

21 Dioptre setting wheel

Setting range from -4 to +4 diopter.

22 Direction pad

For scrolling within the menu and for settings

23 Center button

- **in the menu:**
For confirming settings and calling up submenus
- **in recording mode:**
For calling up the different info screens

24 Status LED

Lights up during input/output to/from the memory card, while using WLAN functions, and during a firmware update

25 Monitor



3" TFT LCD, 1.04 MP, touch control
All settings are indicated in the monitor

26 Door over battery compartment and memory card slot

a Lock/unlock lever

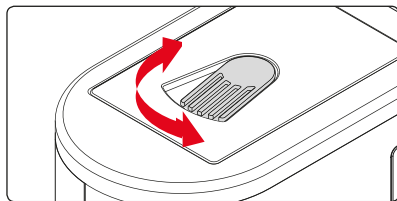

27 Tripod thread

A ¼ DIN 4503 (¼")

28 Battery locking slider

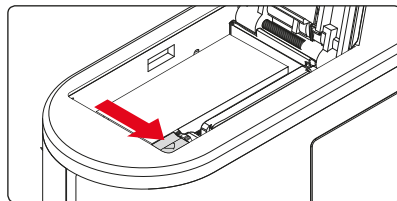

29 Battery compartment

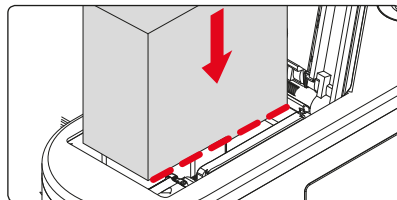

30 memory card slot

UHS-II, UHS-I, SD-/SDHC-/SDXC

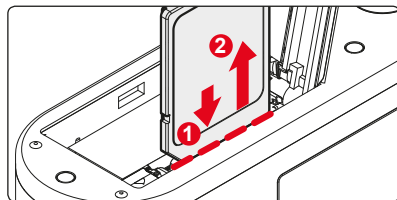

CHARGING THE BATTERY

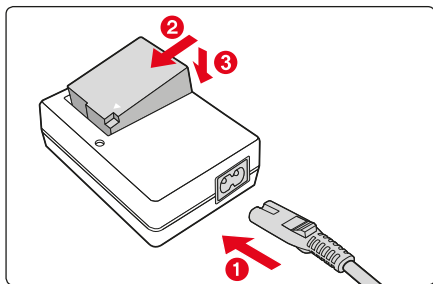

A properly operating charging process is indicated by the status LED lighting up. When it goes out, the battery is fully charged.

SELECTING A RECORDING MODE

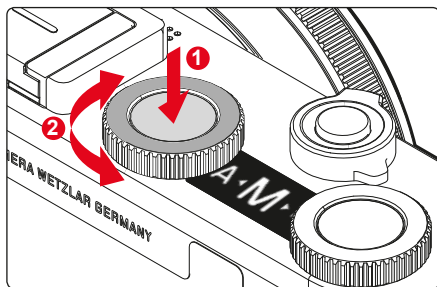

- 1 Press left setting wheel button **14**
- 2 Turn left setting wheel **13** to select recording mode

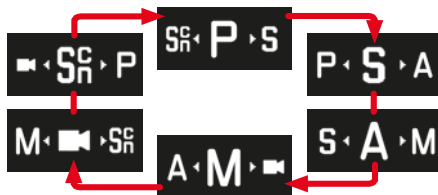

ASSIGNING THE SETTING WHEEL / SETTING WHEEL BUTTON FUNCTIONS

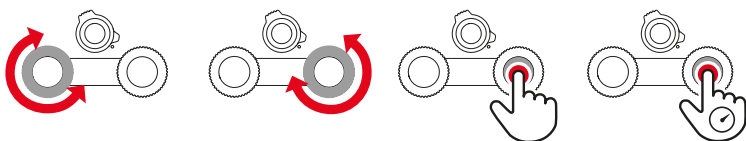

P	Exposure compensation	Program shift	ISO	Changing button assignment
S	Shutter speed	Exposure compensation	ISO	Changing button assignments
A	Exposure compensation	Aperture	ISO	Changing button assignment
M	Shutter speed	Aperture	ISO	Changing button assignment
	Exposure compensation	Exposure compensation	-	Changing button assignment
SCN	Exposure compensation	Exposure compensation	-	Changing button assignment

TOUCH CONTROL OPERATIONS

Touch control

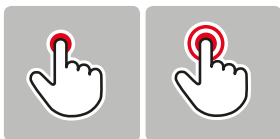

Tap briefly

Tap twice

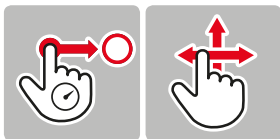

Long touch,
drag and drop

Swipe
horizontally/
vertically

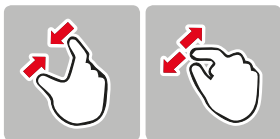

two-finger pinch two-finger spread

Switching: recording/review modes

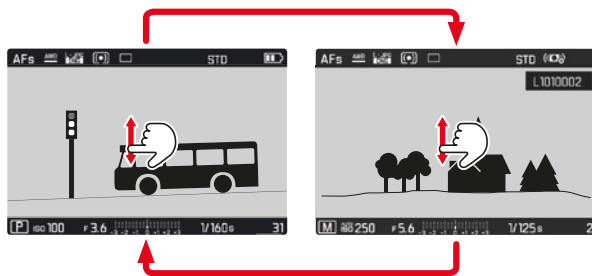

Switching: Photo/Video

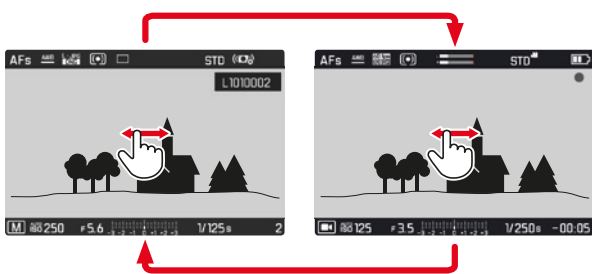

Touch AF

Touch AF allows moving the AF frame by drag and drop, **Touch AF + Release** adds releasing the shutter.

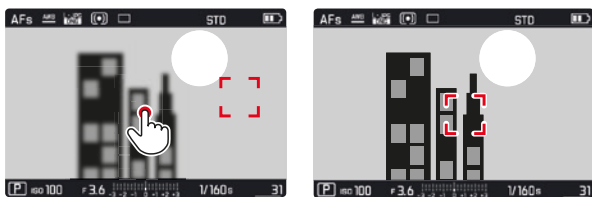

INDIVIDUAL MENU SETTINGS

FAVORITES menu / FN Button / right setting wheel button

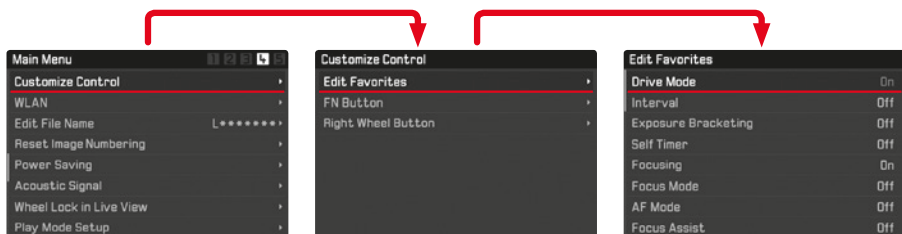

FACTORY SETTING

Main Menu

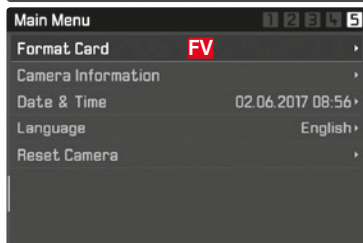
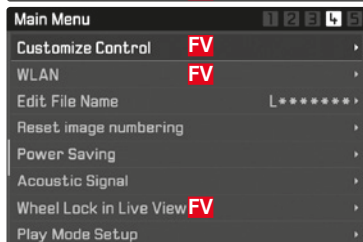
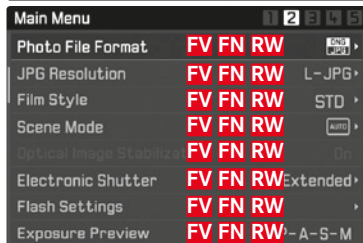
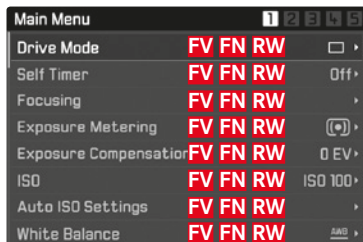

FV Can be assigned to the **FAVORITES** menu list

FN Can be assigned to the **FN Button** menu list

RW Can be assigned to the **right setting wheel button menu list**

FAVORITES Menu

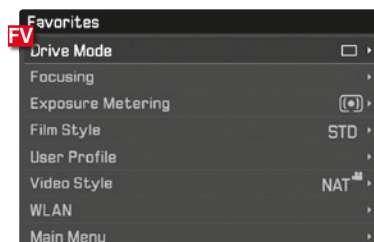

FN Button menu list

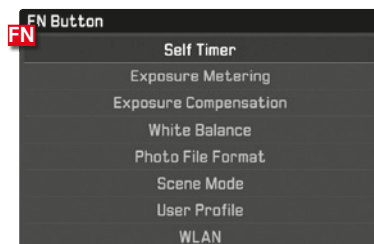

Right setting wheel button menu list

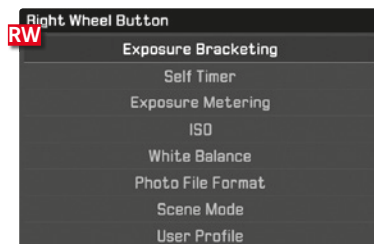

SAFETY NOTES

- Always store small parts (e.g. the accessory shoe cover) as follows:
 - out of reach of children
 - in a location where they will not get lost and will not be stolen
- Modern electronic components react sensitively to electrostatic discharge. As people can easily pick up charges of tens of thousands of volts by walking on synthetic carpets for example, a discharge can occur when you touch your camera, particularly if it is placed on a conductive surface. If only the camera housing is affected, this discharge is harmless to the electronics. However, despite built-in safety circuits, outer contacts such as those in the accessory shoe should not be touched if at all possible for safety reasons.
- For any cleaning of the contacts, do not use an optical micro-fiber cloth (synthetic); use a cotton or linen cloth instead! Before touching the contacts, you can make sure you discharge any electrostatic charge by deliberately touching a heating or water pipe (conductive, grounded material). Dirt deposits and oxidation on the contacts can be avoided by storing your camera in a dry location with the lens cap and flash shoe and viewfinder cap on.
- Use only the recommended accessories to prevent faults, short circuits or electric shock.
- Do not attempt to remove parts of the housing (covers). Repairs must be done at authorized service centers only.
- Do not use your camera in the immediate vicinity of devices with powerful magnetic, electrostatic or electromagnetic fields (e.g. induction ovens, microwave ovens, television sets or computer monitors, video game consoles, cell phones, radio equipment).
- If you place the camera on or very close to a television set, or use it nearby mobile phones, image recording may be disturbed.
- Strong magnetic fields, e.g. from speakers or large electric motors, can damage the stored image data.
- If the camera malfunctions due to the effects of electromagnetic fields, turn it off, remove the battery, and then turn it on again. Do not use the camera in the immediate vicinity of radio transmitters or high-voltage power lines. Their magnetic fields can also interfere with recordings.
- Protect the camera from contact with insect sprays and other aggressive chemicals. Petroleum spirit, thinner and alcohol may not be used for cleaning.
- Certain chemicals and liquids can damage the camera body or the surface finish.
- As rubber and plastics sometimes emit aggressive chemicals, they should not remain in contact with the camera for a long time.
- Ensure that sand and dust cannot get into the camera, e.g. on the beach. This is the case especially when inserting and removing the memory card.
- Ensure that water cannot get into the camera, e.g. when it is snowing or raining and on the beach. Moisture can cause malfunctions and even permanent damage to the camera and the memory card.
- If salt water spray gets onto the camera, wet a soft cloth with tap water, wring it out thoroughly and wipe the camera with it. Then wipe down thoroughly with a dry cloth.
- If condensation has formed on or in the camera, you should turn it off and leave it to stand at room temperature for around an hour. Once the camera temperature has adjusted to room temperature, the condensation will disappear by itself.
- Use carrying straps only for their intended purpose as a carrying strap on a camera / on binoculars. Any other use carries the risk of injury and may possibly result in damage to the carrying strap and is therefore not permitted.
- Carrying straps are usually made of strong material. Keep the carrying strap away from children. It is not a toy and potentially dangerous to children due to a risk of strangulation.
- For the same reason, carrying straps should not be used for cameras/binoculars during sporting activities where there is a high risk of getting caught by the carrying strap (e.g. climbing in the mountains and comparable outdoor sports).

Important:



Use only the accessories specified and described in these instructions or by Leica Camera AG with the camera. If the camera is exposed to significant temperature fluctuations, condensation can form on the monitor. Wipe it off carefully with a soft dry cloth.

- If the camera is very cold when turned on, the monitor image will initially be slightly darker than normal. As soon as the monitor warms up, it will reach its normal level of brightness.
- Cosmic radiation (e.g. during flights) can cause pixel defects.

The monitor is manufactured using a high-precision process. This ensures that of the total of around 1,040,000 pixels more than 99.995% work correctly and only 0.005% remain dark or are always bright. However, this is not a malfunction and it does not impair the reproduction of a recording.

LEGAL INFORMATION

- Please ensure that you observe copyright laws. The recording and publication of pre-recorded media such as tapes, CDs, or other published or broadcast material may contravene copyright laws.
- This also applies to all of the software supplied.
- With regard to videos created using this camera: This product is licensed under the AVC Patent Portfolio license for the personal use of a consumer or other uses in which the consumer does not receive remuneration to (i) encode video in compliance with the AVC standard (“AVC video”) and/or (ii) decode AVC video that was encoded by a consumer engaged in a personal activity and/or was obtained from a video provider licensed to provide AVC video. No license is granted or shall be implied for any other use. Any other use, including but not limited to providing AVC video in exchange for remuneration, may require a separate license agreement with MPEG LA, L.L.C. For more information please visit the MPEG LA, L.L.C. website at: www.mpegla.com
- The SD logo is a registered trademark.
- Other names, company and product names referred to in these instructions are trademarks or registered trademarks of the respective companies.

 Alternating current (AC)	 Class II devices (the product has a double-insulated design)
 Direct current (DC)	

English

Declaration of Conformity (DoC)

Hereby, “Leica Camera AG” declares that this product is in compliance with the essential requirements and other relevant provisions of Directive 2014/53/EU.

Customers can download a copy of the original DoC to our RE products from our DoC server:

www.cert.leica-camera.com

In case of further questions, please contact:

Leica Camera AG, Am Leitz-Park 5, 35578 Wetzlar, Germany

Wireless transmitter:

Frequency range used: 2412 MHz to 2462 MHz (Central frequency)

Max. output power: 20 dBm (EIRP)

The CE identification of our products documents compliance with the fundamental requirements of the applicable EU directives.

The specific approvals for this device can be found in the camera menu.

- ▶ In the **Main Menu** (5. page), select **Camera Information**
- ▶ In the **Camera Information** submenu, select **Regulatory Information**



Disposal of electrical and electronic equipment

(Applies within the EU, and other European countries with segregated waste collection systems)

This device contains electrical and/or electronic components and must therefore not be disposed of in general household waste! Instead, it should be disposed of at a recycling collection point provided by the local authority. This costs you nothing. If the device contains standard or rechargeable batteries, these must be removed first and also be disposed of in line with relevant regulations. Further information on the subject is available from your local administration, your local waste collection company, or in the store where you purchased this device.

Declaration of Conformity (DoC)

Hereby, "Leica Camera AG" declares that this product is in compliance with the essential requirements and other relevant provisions of Directive 2014/53/EU. Customers can download a copy of the original DoC to our RE products from our DoC server: www.cert.leica-camera.com
In case of further questions, please contact:
Leica Camera AG, Am Leitz-Park 5, 35578 Wetzlar, Germany

Wireless Transmitter:

Frequency range used: 2412 MHz to 2462 MHz (Central frequency WLAN)

Max. output power: 13dBm (EIRP)

The CE identification of our products documents compliance with the fundamental requirements of the applicable EU directives.

For United Arab Emirates only:

TRA

REGISTERED No:

ER57270/17

DEALER No:

DA0112968/13

For US and Canada only:



A recyclable lithium ion/polymer battery powers this camera. Please call 1-800-8-BATTERY for information on how to recycle this battery.

This is a Class B product based on the standard of the Voluntary Control Council for Interference from Information Technology Equipment (VCCI). If this is used near a radio or television receiver in a domestic environment, it may cause radio interference. Install and use the equipment according to the instruction manual.

FCC Note:

This equipment has been tested and found to comply with the limits for a Class B digital device, pursuant to Part 15 of the FCC Rules. These limits are designed to provide reasonable protection against harmful interference in a residential installation. This equipment generates, uses, and can radiate radio frequency energy and, if not installed and used in accordance with the instructions, may cause harmful interference to radio communications. However, there is no guarantee that interference will not occur in a particular installation. If this equipment does cause harmful interference to radio or television reception, which can be determined by turning the equipment off and on, the user is encouraged to try to correct the interference by one or more of the following measures:

- Reorient or relocate the receiving antenna.
- Increase the separation between the equipment and receiver.
- Connect the equipment into an outlet on a circuit different from that to which the receiver is connected.
- Consult the dealer or an experienced radio/TV technician for help.

FCC Caution:

To assure continued compliance, follow the attached installation instructions and use only shielded interface cables with ferrite core when connecting to computer or peripheral devices. Any changes or modifications not expressly approved by the party responsible for compliance could void the user's authority to operate this equipment.

Trade Name:	LEICA
Type No.	7323
Responsible party/Support contact:	Leica Camera Inc. 1 Pearl Count, Unit A, Allendale, New Jersey 07401 Tel.: +1 201 995 0051 / Fax: +1 201 995 1684 technicalinfo@leicacamerausa.com

This device complies with Part 15 of the FCC Rules. Operation is subject to the following two conditions: (1) This device may not cause harmful interference, and (2) this device must accept any interference received, including interference that may cause undesired operation.

Type No.: 7323

Tested To Comply
With FCC Standards

FOR HOME OR OFFICE USE

Contains FCC ID: VPLYBXN604

This transmitter must not be co-located or operated in conjunction with any other antenna or transmitter. This equipment complies with FCC radiation exposure limits set forth for an uncontrolled environment and meets the FCC radio frequency (RF) Exposure Guidelines. This equipment has very low levels of RF energy that are deemed to comply without testing of specific absorption ratio (SAR).

For Canada only:

CAN ICES-3 (B)/NMB-3(B)

This device complies with RSS-210 of the IC Rules. Operation is subject to the following two conditions:

- (1) This device may not cause harmful interference,
- (2) This device must accept any interference received, including interference that may cause undesired operation of the device. This equipment complies with IC radiation exposure limits set forth for an uncontrolled environment and meets RSS-102 of the IC radio frequency (RF) Exposure rules. This equipment has very low levels of RF energy that are deemed to comply without testing of specific absorption ratio (SAR).

For Singapore only

Complies with
IDA Standards
DA106734

TECHNICAL DATA

Camera name

Leica CL

Camera type

Digital APS-C system camera

Type no.

7323

Order no.

19 301 (black)

Lens mount

Leica L bayonet with contact strip for communication between lens and camera

Compatible lenses

Lenses with Leica L bayonet, Leica M/R lenses using the Leica M-Adaptor-L/Leica R-Adapter L

Sensor

APS-C-sized CMOS sensor (23.6 x 15.7 mm) with 24.96/24.24 million pixels (total/effective), aspect ratio: 3:2

Storage media

UHS-II, UHS-I, SD-/SDHC-/SDXC-memory cards

Viewfinder

Resolution: 1024 x 768 pixels (2.36 MP), magnification 0.74x, aspect ratio 4:3, exit pupil 20 mm, setting range -4 to +4 dioptr., with eye sensor for automatic switching between viewfinder and monitor

Top display

Resolution: 128 x 58 pixel

Monitor

3" TFT LCD, 1.04 MP, touch control available

Power supply

Leica BP-DC12 lithium-ion battery, rated voltage: 7.2 V \equiv (DC), capacity: 1200 mAh (min.), (based on CIPA standards): approx. 220 pictures, charging time (after total discharge): approx. 140 min, manufacturer: Panasonic Energy (Wuxi) Co. Ltd., made in China

Charger

Leica BC-DC12, input: AC 100–240 V, 50/60 Hz, automatic switching, output: DC 8.4 V 0.65 A, manufacturer: Shin Tech Engineering Ltd., Made in China

Body

Top and bottom panels: milled and anodized aluminum, front and rear panels: magnesium

Dimensions (WxHxD)

approx. 131 x 78 x 45 mm

Weight

approx. 403 g/353 g (with/without battery)

The production date of your camera can be found on the stickers in the Guarantee Card and/or on the packaging. The format is year/month/day. Subject to changes in design and production.